



SMART ACCESS

Smart Locks, Access Control,
Mobile App & SaaS Software



RESIDENTIAL

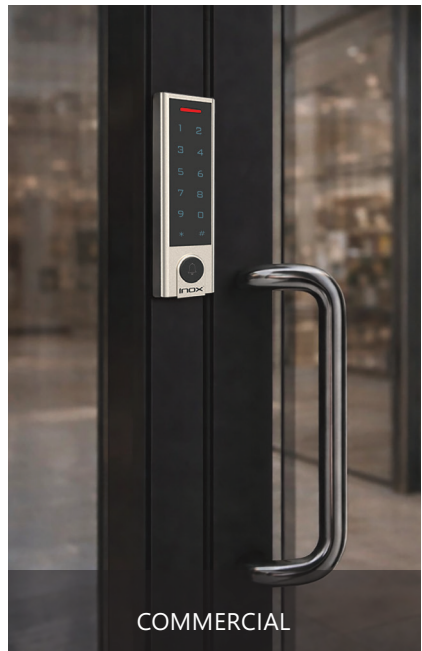

COMMERCIAL

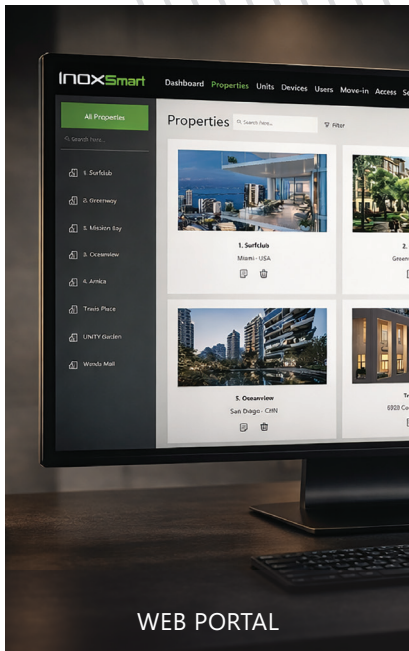

WEB PORTAL



SMART APP

TABLE OF CONTENTS

SMART PRODUCT INTEGRATION SOLUTIONS

ISM-SFK Smart Mortise Full Plate with Keypad.....	Page 04
ISM-SFR Smart Mortise Full Plate with Reader.....	Page 09
ISM-SFK Smart Mortise Sectional with Keypad.....	Page 14
ISM-SFR Smart Mortise Sectional with Reader	Page 19
ISC Smart Cylindrical.....	Page 25
ISD Smart Deadbolt	Page 31
IST Smart Tubular Interconnect.....	Page 37
IST Smart Sectional Interconnect.....	Page 42
ISTH-BWK Smart Tubular Entry Handleset.....	Page 49
ISTH-HUK Smart Tubular Entry Handleset.....	Page 55
ISM-PD95 Smart Sliding Door Lock Sectional With Keypad.....	Page 63
ISM-PD95 Smart Sliding Door Lock With Full Plate Keypad.....	Page 68
ISM-PD95 Smart Sliding Door Sectional Lock With Reader.....	Page 73
ISM-PD95 Smart Sliding Door Full Plate Lock With Reader.....	Page 78
ISMP Smart Multipoint Trim	Page 85
ISED Smart Exit Device Trim.....	Page 93
ISGK-B750 Smart Glass Door Lock.....	Page 99
ISK-B300 Multi-Credential Reader Controller.....	Page 103
ACBX Access Control In A Box Series.....	Page 106
AX7001 Smart Reader Controller Kit.....	Page 108
ISGW-BLE21 Plug-In Gateway.....	Page 110
ISGW-BP22-SP-WH Smart PoE Gateway (Micro-USB).....	Page 111
ISGW-BP22C-SP-WH Smart PoE Gateway (USB Type C)	Page 112
Door Position Sensors for Wood/Metal Doors & Frames.....	Page 113
INOX Smart Mobile Control And Web Portal.....	Page 116

Smart Mortise Locks



SMART MORTISE

FULL PLATE WITH KEYPAD

The INOX App paired with our smart touchscreen keypad manages multiple users and properties with real-time access control to provide enhanced security and convenience at your fingertips.



CODE COMPLIANCE

- ANSI/BHMA A156.13 Grade 1 Mortise
- UL Listed for 3 hour fire doors
- CAN/ULC S104 up to 3 hours
- UBC Standard 7-2 (1997) NFPA 252
- NFPA 80 National Fire Protection (Fire Door Assembly)
- NFPA101 National Fire Protection
- ANSI A117.1 ADA Accessibility

FINISHES

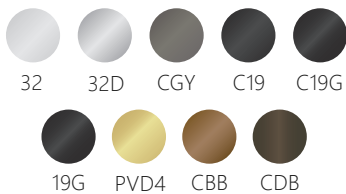

PRODUCT SERIES

ISM-SFK

FEATURES

- Touch-to-Lock keypad allows locking with a simple touch—no device or key required for access
- Entry function with easily programmable Privacy and Passage modes with optional key override
- Patent Pending design allows for installation without special door prep
- Battery powered (4 x AA alkaline) with 9V emergency power access
- Motor-driven deadbolt enables auto-locking functionality
- Privacy and Passage mode available via interior toggle button. (Must first be activated through Keypad)
- Inside lever egress simultaneously retracts both deadbolt and latch, ensuring fast and secure exit
- Standard exterior and interior gasket included, installation optional
- Compatible Door Position Sensor (DPS) for Metal included (Wood must be ordered separately)

SPECIFICATIONS

Lockcase Backset	2-3/4" (70mm)
Center-to-Center Distance	Lever to Cylinder: 3-7/8" (98mm) Lever to Thumbturn: 2-11/16" (68mm)
Cylinder	Schlage C keyway 6 pin, 1-1/4" mortise cylinder Optional SFIC and LFIC housing and cores available
CAM	CAM01-SCL Clover Cam
Materials	Lockcase: Heavy gauge Steel Bolt: Stainless Steel Faceplate/Strike: Stainless Steel Cylinder: Solid Brass
	Trim: Stainless Steel

FEATURED CALLOUTS



FUNCTIONS

- 

MC7438
Entrance without Toggle

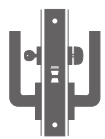
 - Key or thumbturn controls deadbolt; lever operates latch
 - Inside lever always allows exit; outside can be locked
 - Auto-deadlocking with optional locked indicator
- 

MC7050
Office and Inner Entry

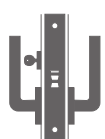
 - Lever operates latch; outside can be locked by key or thumbturn
 - When locked, key (outside) or inside lever retracts latch
 - No deadbolt; auto-deadlocking latch with optional locked indicator
- 

MC7080
Entry without Toggle, without Thumbturn

 - Functions as a Classroom Function — locking is achieved mechanically by key only; door may remain unlocked when desired
 - With auto-locking enabled via app, functions as a Storeroom Function — door remains locked at all times and can be unlocked only by key, RFID credential, or authorized app access

REPLACEMENT CYLINDERS & CORES

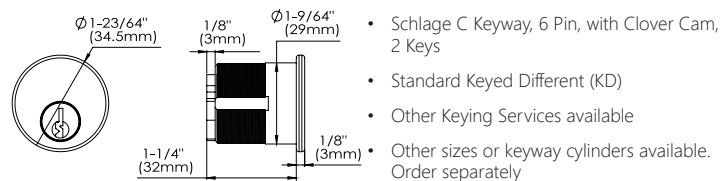

Standard Mortise Cylinder

- 

CMB1146

 - Mortise Cylinder, Schlage C Keyway, 6 pin, L Cam 1-1/4"
 - Keyed Alike (KA), Master Key (MK), Grand Master Key (GMK), Construction Master Key (CMK) Available

Standard SFIC & LFIC Housing

- 

CMB1146

 - Small Format Interchangeable Cylinder (SFIC) Housing 1-1/4", 6-Pin, Less Core, L Clover Cam
- CMB1387

 - Small Format Interchangeable Cylinder (SFIC) Housing 1-3/8", 7-Pin, Less Core, L Clover Cam
- CMB1126

 - Large Format Interchangeable Cylinder (LFIC) Housing 1-1/2", 6-Pin, Less Core, L Clover Cam

Interchangeable Cores

- 

SFIC 6

 - CMB-ICBA6-CMB - SFIC 6 Pin Core
- SFIC 7

 - CMB-ICBA7-CMB - SFIC 7 Pin Core

DIMENSIONS

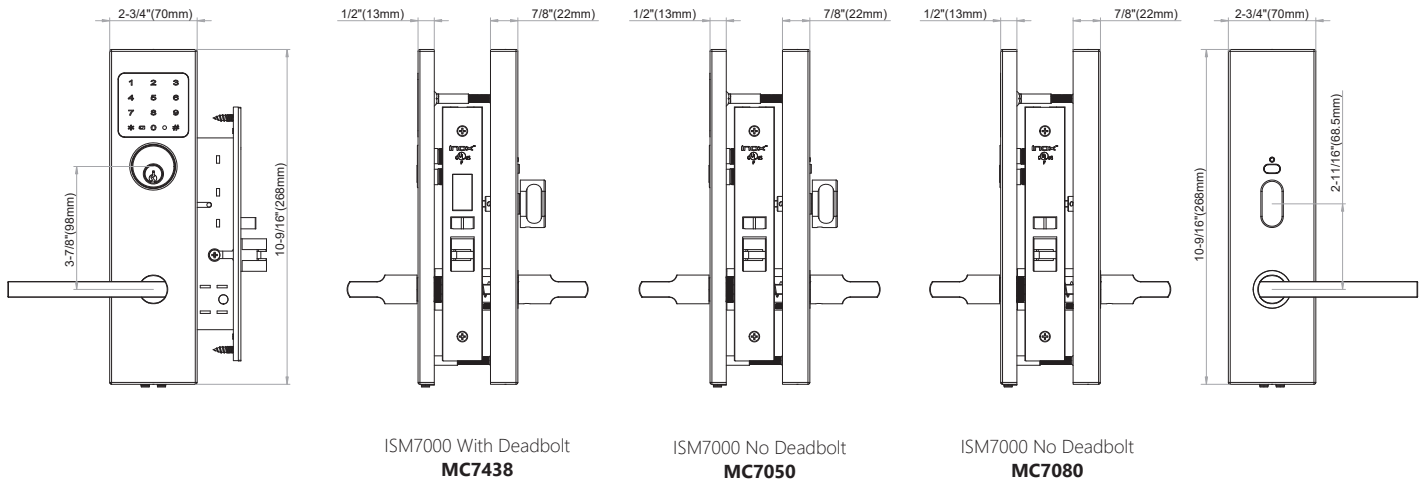





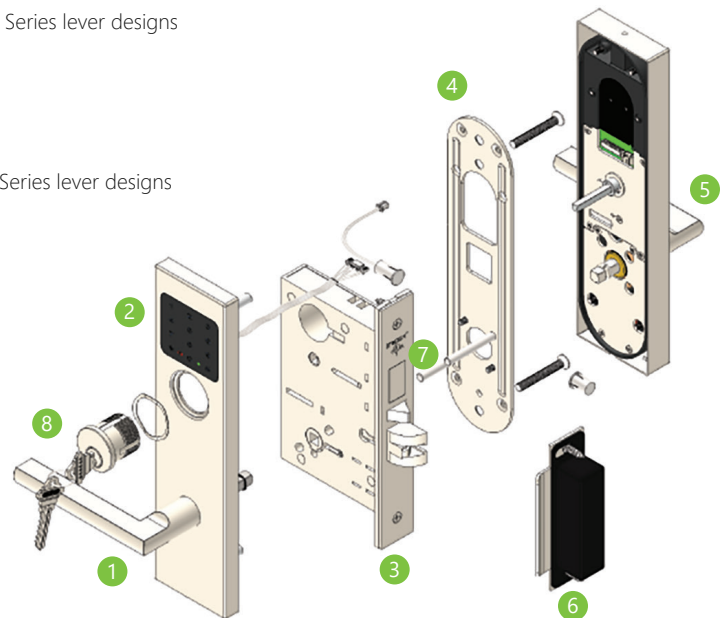











COMPONENTS

- 1 Exterior heavy-duty stainless steel cast plate with choice of X Series lever designs
- 2 Touch-to-Lock Keypad
- 3 ISM7000 lockcase and faceplate; 2-3/4" backset
- 4 Interior sub-plate
- 5 Interior heavy duty stainless steel cast plate with choice of X Series lever designs
- 6 Commercial Mortise Lock Strike 4-7/8" x 1-7/8"
- 7 1" (25.4mm) heavy-duty deadbolt
- 8 Schlage C keyway, 6 pin 1-1/4" mortise cylinder



HOW TO ORDER

Use the sequence below to create an item code for ordering. Please see price book for parts or additional service upcharges.

PRODUCT	PLATE	LEVER	LOCK	READER/WRITER	CYLINDER	THUMBTURN	FINISH	HANDING
ISM	-SFK	243-	-MC7438	-BRW			-32D	-LH
1	2	3	4		5	6	7	8
PLATE	LEVER		LOCK					
								
	201	202	205	221	243			
								
	244	276	318	319	320			
								
	321	328	345	346	509			
SFK								

- MC7438 = Deadbolt Entry w/o Toggle
- MC7050 = Entry w/o Toggle
- MC7080 = Classroom Function w/o Toggle
*When Autolocking is OFF
Storeroom Function w/o Toggle
*When Autolocking is On
- MDP = Mortise Dummy Pair

5 CYLINDER AND HOUSING (INCLUDES COLLAR)

- LC = Less Cylinder
- Blank = Standard Mortise 1-1/4" Cylinder
- S6 = Small Format Interchangeable Cylinder (SFIC) Housing 1-1/4", 6-Pin, Less Core, L Clover Cam
- S7 = Small Format Interchangeable Cylinder (SFIC) Housing 1-3/8", 7-Pin, Less Core, L Clover Cam
- L6 = Large Format Interchangeable Cylinder (LFIC) Housing 1-1/2", 6-Pin, Less Core, L Clover Cam
- Order IC Cores and Thick Door Kits (TDKs) separately. (See Price Book)

6 THUMBTURN



7 FINISHES* (STANDARD)

-  32D Satin Stainless Steel
-  32 Bright Stainless Steel
-  19G Graphite Black
-  PVD4 Satin Brass
-  Ceramax Graphite Black (C19G)
-  Ceramax Flat Black (C19)
-  Ceramax Stormy Grey (CGY)
-  Ceramax Dark Bronze (CDB)
-  Ceramax Burnt Bronze (CBB)

8 HANDING

- RH = Right Hand
- LH = Left Hand
- RHR = Right Hand Reverse
- LHR = Left Hand Reverse

*Please see Finish Solutions on INOX website for special order finishes.

LEVER DESIGN OPTION



201 COLOGNE
SHOWN AS
19G GRAPHITE BLACK



202 MUNICH
SHOWN AS
32D SATIN STAINLESS STEEL



205 FRANKFURT
SHOWN AS
CERAMAX BURNT BRONZE



221 AURORA
SHOWN AS
CERAMAX STORMY GREY



243 SUNRISE
SHOWN AS
32 BRIGHT STAINLESS STEEL



244 TWILIGHT
SHOWN AS
CERAMAX DARK BRONZE



276 PLAZA
SHOWN AS
PVD4 SATIN BRASS



318 CAFE
SHOWN AS
CERAMAX FLAT BLACK (C19)



319 HAMPTON
SHOWN AS
CERAMAX GRAPHITE BLACK



320 EMPIRE
SHOWN AS
32 BRIGHT STAINLESS STEEL



321 VALENCIA
SHOWN AS
19G GRAPHITE BLACK



328 JAVA
SHOWN AS
32 BRIGHT STAINLESS STEEL



345 TOKYO
SHOWN AS
CERAMAX BURNT BRONZE



346 OSAKA
SHOWN AS
CERAMAX STORMY GREY



509 STUTTGARD
SHOWN AS
32 BRIGHT STAINLESS STEEL

**All Exterior Trim Configurations above are shown in Right Hand (RH) Door Configuration*

SMART MORTISE

FULL PLATE WITH READER

The intuitive INOX App along side the Smart Mortise Lock with Reader enables you to manage multiple users and properties with real-time access control for enhanced security and convenience.



CODE COMPLIANCE

- ANSI/BHMA A156.13 Grade 1 Mortise
- UL Listed for 3 hour fire doors
- CAN/ULC S104 up to 3 hours
- UBC Standard 7-2 (1997) NFPA 252
- NFPA 80 National Fire Protection (Fire Door Assembly)
- NFPA101 National Fire Protection
- ANSI A117.1 ADA Accessibility

FEATURES

- Touch-to-Lock screen allows locking with a simple touch—no device or key required for access
- Entry function with easily programmable Privacy and Passage modes with optional key override
- Patent Pending design allows for installation without special door prep
- Battery powered (4 x AA alkaline) with 9V emergency power access
- Motor-driven deadbolt enables auto-locking functionality
- Privacy and Passage mode available via interior toggle button. (Must first be activated through Keypad)
- Inside egress lever simultaneously retracts both deadbolt and latch, ensuring fast and secure exit

FINISHES

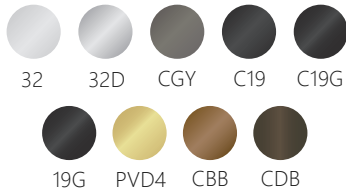

PRODUCT SERIES

ISM-SFR

SPECIFICATIONS

Lockcase Backset	2-3/4" (70mm)
Center-to-Center Distance	Lever to Cylinder: 3-7/8" (98mm) Lever to Thumbturn: 2-11/16" (68mm)
Cylinder	Schlage C keyway 6 pin, 1-1/4" mortise cylinder Optional SFIC and LFIC housing and cores available
CAM	CAM01-SCL Clover Cam
Materials	Lockcase: Heavy gauge Steel Bolt: Stainless Steel Faceplate/Strike: Stainless Steel Cylinder: Solid Brass Trim: Stainless Steel

FEATURED CALLOUTS

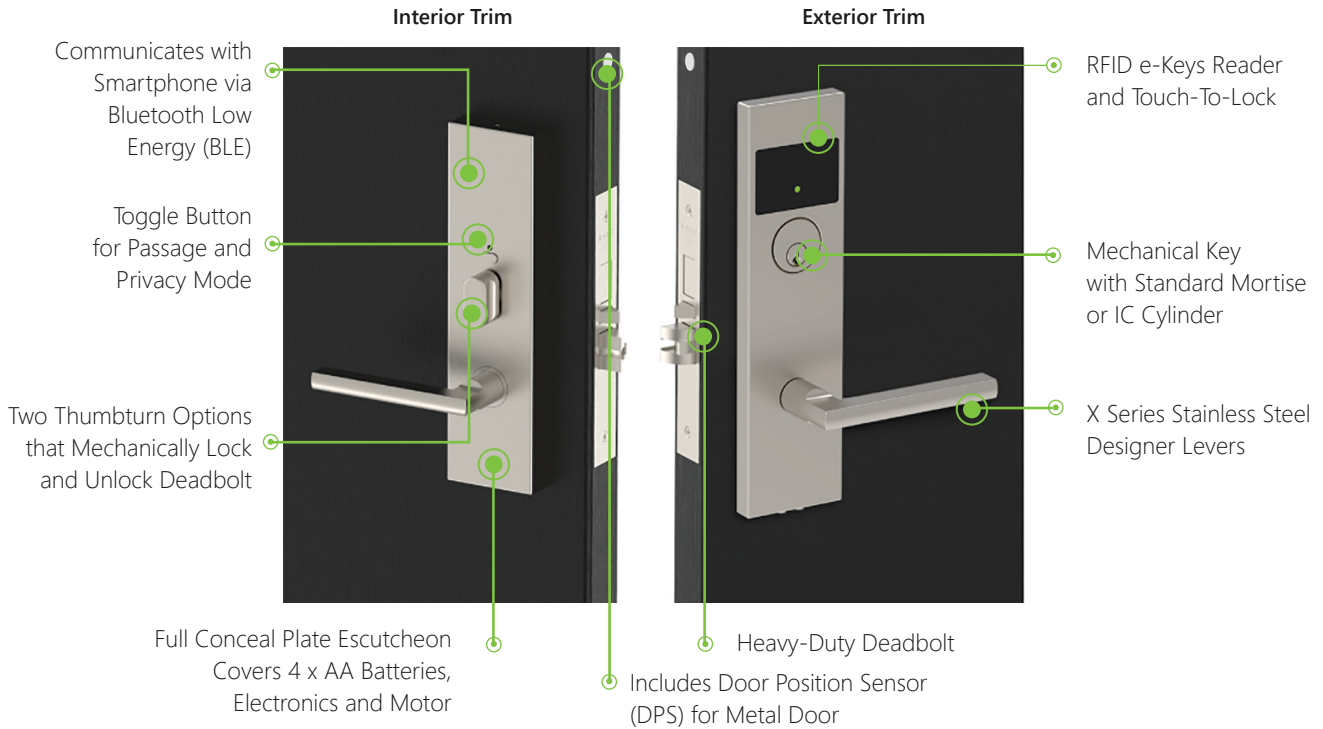

FUNCTIONS

- MC7438**
Entrance without Toggle
- Key or thumbturn controls deadbolt; lever operates latch.
 - Inside lever always allows exit; outside can be locked.
 - Auto-deadlocking with optional locked indicator.

- MC7050**
Office and Inner Entry
- Lever operates latch; outside can be locked by key or thumbturn.
 - When locked, key (outside) or inside lever retracts latch.
 - No deadbolt; auto-deadlocking latch with optional locked indicator.

- MC7080**
Entry without Toggle, without Thumbturn
- Functions as a Classroom Function — locking is achieved mechanically by key only; door may remain unlocked when desired
 - With auto-locking enabled via app, functions as a Storeroom Function — door remains locked at all times and can be unlocked only by key, RFID credential, or authorized app access.

REPLACEMENT CYLINDERS & CORES

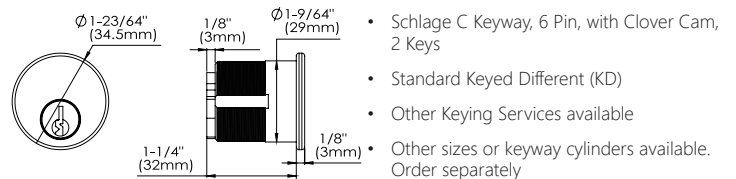

Standard Mortise Cylinder

- CMB1146**
- Mortise Cylinder, Schlage C Keyway, 6 pin, L Cam 1-1/4"
 - Keyed Alike (KA), Master Key (MK), Grand Master Key (GMK), Construction Master Key (CMK) Available

Standard SFIC & LFIC Housing

- CMB1146**
- Small Format Interchangeable Cylinder (SFIC) Housing 1-1/4", 6-Pin, Less Core, L Clover Cam
- CMB1387**
- Small Format Interchangeable Cylinder (SFIC) Housing 1-3/8", 7-Pin, Less Core, L Clover Cam
- CMB1126**
- Large Format Interchangeable Cylinder (LFIC) Housing 1-1/2", 6-Pin, Less Core, L Clover Cam

Interchangeable Cores

- SFIC 6**
- CMB-ICBA6-CMB - SFIC 6 Pin Core
- SFIC 7**
- CMB-ICBA7-CMB - SFIC 7 Pin Core

DIMENSIONS

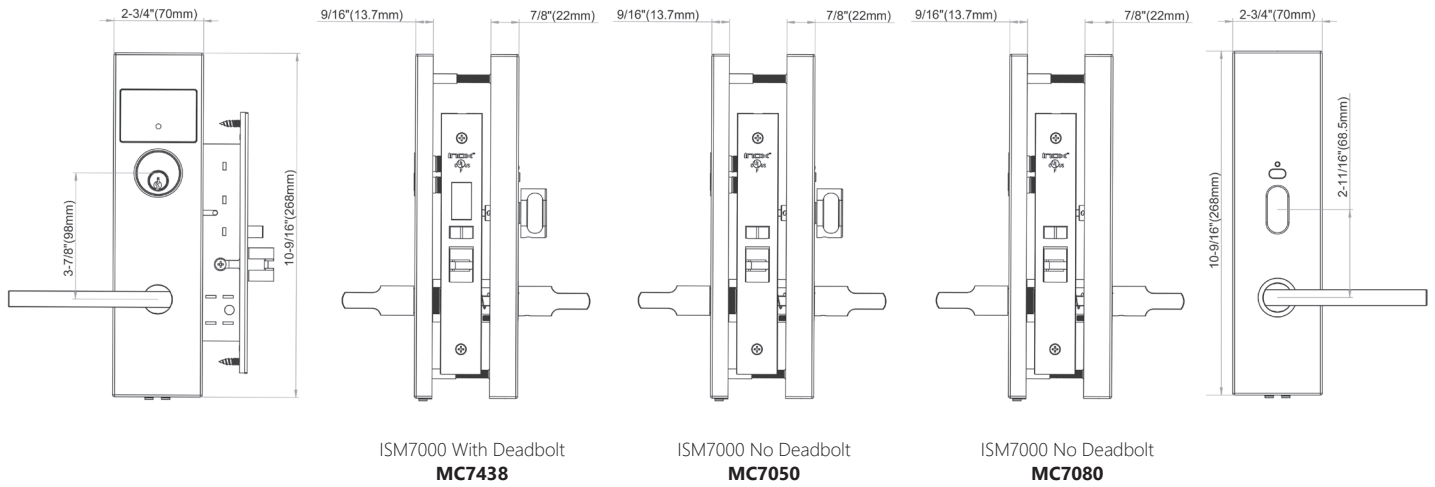

COMPONENTS

- 1 Exterior heavy-duty stainless steel cast plate with choice of X Series lever designs
- 2 Touch-to-Lock Keypad
- 3 ISM7000 lockcase and faceplate; 2-3/4" backset
- 4 Interior sub-plate
- 5 Interior heavy duty stainless steel cast plate with choice of X Series lever designs
- 6 Commercial Mortise Lock Strike 4-7/8" x 1-7/8"
- 7 1" (25.4mm) heavy-duty deadbolt
- 8 Schlage C keyway, 6 pin 1-1/4" mortise cylinder



HOW TO ORDER

Use the sequence below to create an item code for ordering. Please see price book for parts or additional service upcharges.

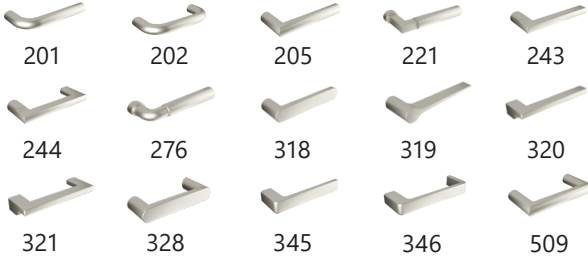
PRODUCT	PLATE	LEVER	LOCK	READER/WRITER	CYLINDER	THUMBTURN	FINISH	HANDING
ISM	-SFR	243	-MC7438	-BRW			-32D	-LH
1	2	3	4		5	6	7	8
PLATE		LEVER			LOCK			
					<ul style="list-style-type: none"> • MC7438 = Deadbolt Entry w/o Toggle • MC7050 = Entry w/o Toggle • MC7080 = Classroom Function w/o Toggle *When Autolocking is OFF Storeroom Function w/o Toggle *When Autolocking is On • MDP = Mortise Dummy Pair 			
SFR								

5 CYLINDER AND HOUSING (INCLUDES COLLAR)

- LC = Less Cylinder
- Blank = Standard Mortise 1-1/4" Cylinder
- S6 = Small Format Interchangeable Cylinder (SFIC) Housing 1-1/4", 6-Pin, Less Core, L Clover Cam
- S7 = Small Format Interchangeable Cylinder (SFIC) Housing 1-3/8", 7-Pin, Less Core, L Clover Cam
- L6 = Large Format Interchangeable Cylinder (LFIC) Housing 1-1/2", 6-Pin, Less Core, L Clover Cam
- Order IC Cores and Thick Door Kits (TDKs) separately. (See Price Book)

6 THUMBTURN



9 FINISHES* (STANDARD)

-  32D Satin Stainless Steel
-  32 Bright Stainless Steel
-  19G Graphite Black
-  PVD4 Satin Brass
-  Ceramax Graphite Black (C19G)
-  Ceramax Flat Black (C19)
-  Ceramax Stormy Grey (CGY)
-  Ceramax Dark Bronze (CDB)
-  Ceramax Burnt Bronze (CBB)

6 HANDING

- RH = Right Hand
- LH = Left Hand
- RHR = Right Hand Reverse
- LHR = Left Hand Reverse

*Please see Finish Solutions on INOX website for special order finishes.

LEVER DESIGN OPTIONS



201 COLOGNE
SHOWN AS
19G GRAPHITE BLACK



202 MUNICH
SHOWN AS
32D SATIN STAINLESS STEEL



205 FRANKFURT
SHOWN AS
CERAMAX BURNT BRONZE



221 AURORA
SHOWN AS
CERAMAX STORMY GREY



243 SUNRISE
SHOWN AS
32D SATIN STAINLESS STEEL



244 TWILIGHT
SHOWN AS
CERAMAX DARK BRONZE



276 PLAZA
SHOWN AS
PVD4 SATIN BRASS



318 CAFE
SHOWN AS
CERAMAX FLAT BLACK (C19)



319 HAMPTON
SHOWN AS
CERAMAX GRAPHITE BLACK



320 EMPIRE
SHOWN AS
32D SATIN STAINLESS STEEL



321 VALENCIA
SHOWN AS
19G GRAPHITE BLACK



328 JAVA
SHOWN AS
32D SATIN STAINLESS STEEL



345 TOKYO
SHOWN AS
CERAMAX BURNT BRONZE



346 OSAKA
SHOWN AS
CERAMAX STORMY GREY



509 STUTTGARD
SHOWN AS
32 BRIGHT STAINLESS STEEL

**All Exterior Trim Configurations above are shown in Right Hand (RH) Door Configuration*

SMART MORTISE

SECTIONAL WITH KEYPAD

The INOX App paired with our smart touchscreen keypad, manages multiple users and properties with real-time access control to provide enhanced security and convenience at your fingertips.



CODE COMPLIANCE

- BHMA/ANSI Grade 1
- UL Listed for 3 hour fire doors
- CAN/ULC S104 up to 3 hours
- UBC Standard 7-2 (1997) NFPA 252
- NFPA 80 National Fire Protection (Fire Door Assembly)
- NFPA101 National Fire Protection
- ANSI A117.1 ADA Accessibility

FEATURES

- Touch-to-Lock keypad allows locking with a simple touch—no device or key required for access
- Entry function with easily programmable Privacy and Passage modes with optional key override
- Patent Pending design allows for installation without special door prep
- Battery powered (4 x AA alkaline) with 9V emergency power access
- Motor-driven deadbolt enables auto-locking functionality
- Inside egress lever simultaneously retracts both deadbolt and latch, ensuring fast and secure exit
- Weather-resistant stainless steel construction (effective when used with separate weather seals)
- Standard exterior and interior gasket included, installation optional
- Compatible Door Position Sensor (DPS) for Metal included (Wood must be ordered separately)

FINISHES

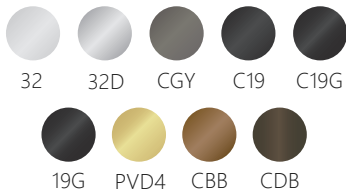

PRODUCT SERIES

ISM-SFK-K1

SPECIFICATIONS

Lockcase Backset	2-3/4" (70mm)
Center-to-Center Distance	Lever to Cylinder: 3-7/8" (98mm) Lever to Thumbturn: 2-11/16" (68mm)
Cylinder	Schlage C keyway 6 pin, 1-1/4" mortise cylinder Optional SFIC and LFIC housing and cores available
CAM	CAM01-SCL Clover Cam
Materials	Lockcase: Heavy gauge Steel Bolt: Stainless Steel Faceplate/Strike: Stainless Steel Cylinder: Solid Brass Trim: Stainless Steel

FEATURED CALLOUTS



FUNCTIONS

- 

MC7438
Entrance without Toggle

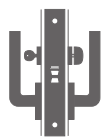
 - Key or thumbturn controls deadbolt; lever operates latch.
 - Inside lever always allows exit; outside can be locked.
 - Auto-deadlocking with optional locked indicator.
- 

MC7050
Office and Inner Entry

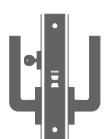
 - Lever operates latch; outside can be locked by key or thumbturn.
 - When locked, key (outside) or inside lever retracts latch.
 - No deadbolt; auto-deadlocking latch with optional locked indicator.
- 

MC7080
Entry without Toggle, without Thumbturn

 - Functions as a Classroom Function — locking is achieved mechanically by key only; door may remain unlocked when desired
 - With auto-locking enabled via app, functions as a Storeroom Function — door remains locked at all times and can be unlocked only by key, RFID credential, or authorized app access.

REPLACEMENT CYLINDERS & CORES

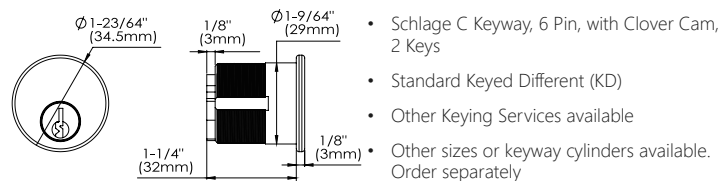

Standard Mortise Cylinder

- 

CMB1146

 - Mortise Cylinder, Schlage C Keyway, 6 pin, L Cam 1-1/4"
 - Keyed Alike (KA), Master Key (MK), Grand Master Key (GMK), Construction Master Key (CMK) Available

Standard SFIC & LFIC Housing

- 

CMB1146

 - Small Format Interchangeable Cylinder (SFIC) Housing 1-1/4", 6-Pin, Less Core, L Clover Cam
- CMB1387

 - Small Format Interchangeable Cylinder (SFIC) Housing 1-3/8", 7-Pin, Less Core, L Clover Cam
- CMB1126

 - Large Format Interchangeable Cylinder (LFIC) Housing 1-1/2", 6-Pin, Less Core, L Clover Cam

Interchangeable Cores

- 

SFIC 6

 - CMB-ICBA6-CMB - SFIC 6 Pin Core
- SFIC 7

 - CMB-ICBA7-CMB - SFIC 7 Pin Core

DIMENSIONS

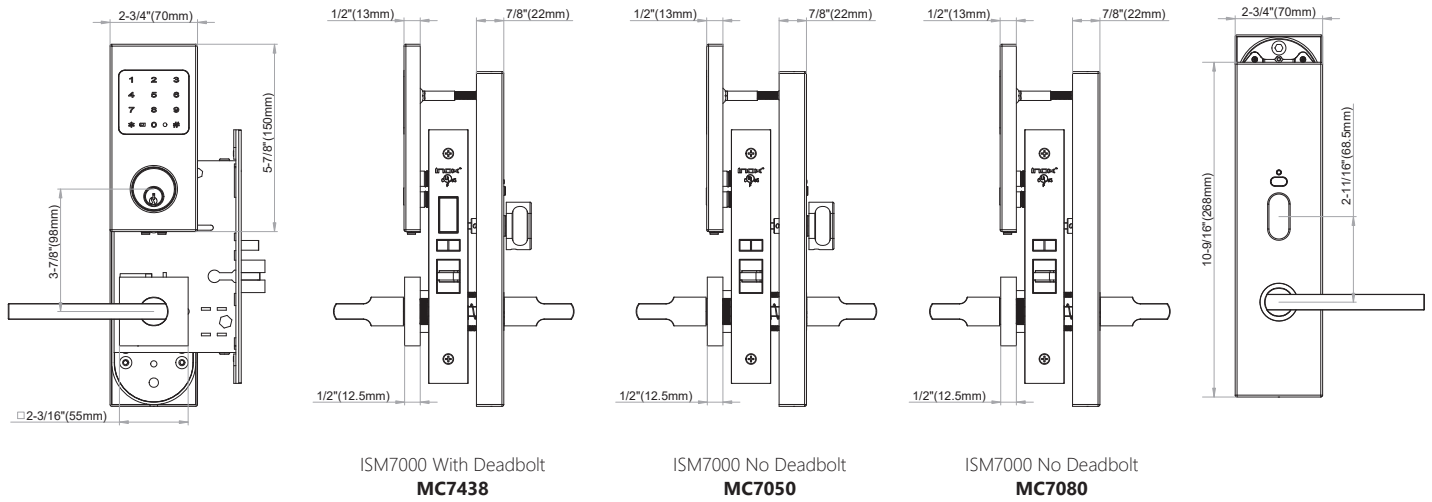





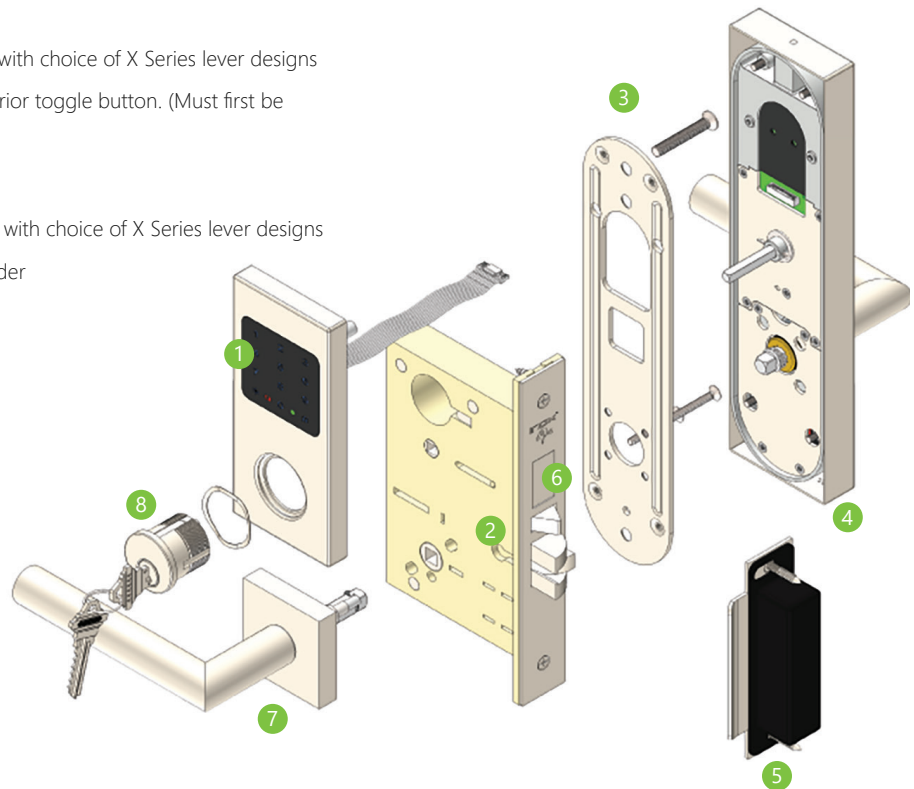











COMPONENTS

- 1 Touch-to-Lock Keypad accepts RFID, Bluetooth, and Passcode credentials
- 2 MC7000 Lockcase and Faceplate; 2-3/4" backset
- 3 Interior sub-plate
- 4 Interior heavy duty stainless steel cast plate with choice of X Series lever designs
- 5 Privacy and Passage mode available via interior toggle button. (Must first be activated through Keypad)
- 6 1" (25.4mm) heavy-duty deadbolt
- 7 Exterior heavy-duty stainless steel cast plate with choice of X Series lever designs
- 8 Schlage C keyway, 6 pin 1-1/4" mortise cylinder



HOW TO ORDER

Use the sequence below to create an item code for ordering. Please see price book for parts or additional service upcharges.

PRODUCT	ROSE	PLATE	LEVER	LOCK	KEYPAD	CYLINDER	THUMBTURN	FINISH	HANDING
ISM	-XGT	-SFK	243	-MC7438	-K1	-S6		-32D	-LH
1	2	3	4	5	6	7	8	9	10
ROSE	PLATE	LEVER		LOCK					
 XGT	 SFK	 201  202  244  276  321  328	 205  221  243  318  319  320  345  346  509	<ul style="list-style-type: none"> • MC7438 = Deadbolt Entry w/o Toggle • MC7050 = Entry w/o Toggle • MC7080 = Classroom Function w/o Toggle *When Autolocking is OFF Storeroom Function w/o Toggle *When Autolocking is On • MDP = Mortise Dummy Pair 					

6 KEYPAD



7 CYLINDER AND HOUSING (INCLUDES COLLAR)

- LC = Less Cylinder
- Blank = Standard Mortise 1-1/4" Cylinder
- S6 = SFIC 6-Pin Cylinder Housing
- S7 = SFIC 7-Pin Cylinder Housing

8 THUMBTURN



9 FINISHES* (STANDARD)

-  32D Satin Stainless Steel
-  32 Bright Stainless Steel
-  19G Graphite Black
-  PVD4 Satin Brass
-  Ceramax Graphite Black (C19G)
-  Ceramax Flat Black (C19)
-  Ceramax Stormy Grey (CGY)
-  Ceramax Dark Bronze (CDB)
-  Ceramax Burnt Bronze (CBB)

10 HANDING

- RH = Right Hand
- LH = Left Hand
- RHR = Right Hand Reverse
- LHR = Left Hand Reverse

*Please see Finish Solutions on INOX website for special order finishes.

LEVER DESIGN OPTIONS



201 COLOGNE
SHOWN AS
19G GRAPHITE BLACK



202 MUNICH
SHOWN AS
32D SATIN STAINLESS STEEL

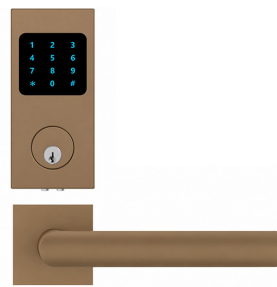

205 FRANKFURT
SHOWN AS
CERAMAX BURNT BRONZE



221 AURORA
SHOWN AS
CERAMAX STORMY GREY



243 SUNRISE
SHOWN AS
32D SATIN STAINLESS STEEL



244 TWILIGHT
SHOWN AS
CERAMAX DARK BRONZE

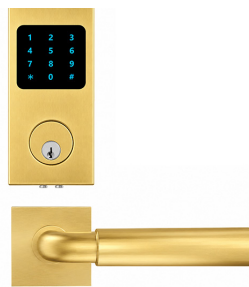

276 PLAZA
SHOWN AS
PVD4 SATIN BRASS

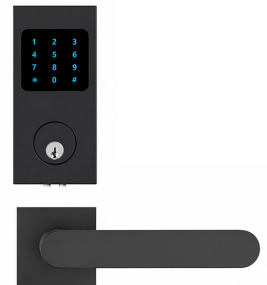

318 CAFE
SHOWN AS
CERAMAX FLAT BLACK (C19)



319 HAMPTON
SHOWN AS
CERAMAX GRAPHITE BLACK



320 EMPIRE
SHOWN AS
32 BRIGHT STAINLESS STEEL



321 VALENCIA
SHOWN AS
19G GRAPHITE BLACK



509 STUTTGARD
SHOWN AS
32 BRIGHT STAINLESS STEEL



345 TOKYO
SHOWN AS
CERAMAX BURNT BRONZE



346 OSAKA
SHOWN AS
CERAMAX STORMY GREY

**All Exterior Trim Configurations above are shown in Right Hand (RH) Door Configuration*

SMART MORTISE

SECTIONAL WITH READER

A perfect solution across commercial, mixed-use, hospitality and residential applications.



CODE COMPLIANCE

- BHMA/ANSI Grade 1 Mortise
- UL Listed for 3 hour fire doors
- CAN/ULC S104 up to 3 hours
- UBC Standard 7-2 (1997) NFPA 252
- NFPA 80 National Fire Protection (Fire Door Assembly)
- NFPA101 National Fire Protection
- ANSI A117.1 ADA Accessibility

FEATURES

- Touch-to-Access reader allows unlocking with a simple touch using an RFID or mobile device
- Entry function with easily programmable Privacy and Passage modes with optional key override
- Patent Pending design allows for installation without special door prep
- Battery powered (4 x AA alkaline) with 9V emergency power access
- Motor-driven deadbolt enables auto-locking functionality
- Inside lever egress simultaneously retracts both deadbolt and latch, ensuring fast and secure exit
- Privacy and Passage mode available via interior toggle button. (Must first be activated through Keypad)
- Optional interior weather gasket

FINISHES

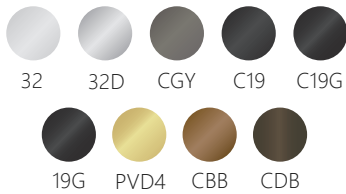

PRODUCT SERIES

ISM-SFR-R1

SPECIFICATIONS

Lockcase Backset	2-3/4" (70mm)
Center-to-Center Distance	Lever to Cylinder: 3-7/8" (98mm) Lever to Thumbturn: 2-11/16" (68mm)
Cylinder	Schlage C keyway 6 pin 1-1/4" Mortise cylinder with 2 keys (standard)
CAM	Optional SFIC and LFIC housing and cores available
Materials	CAM01-SCL Clover Cam Lockcase: Heavy gauge Steel Bolt: Stainless Steel Faceplate/Strike: Stainless Steel Cylinder: Solid Brass Trim: Stainless Steel

FEATURED CALLOUTS

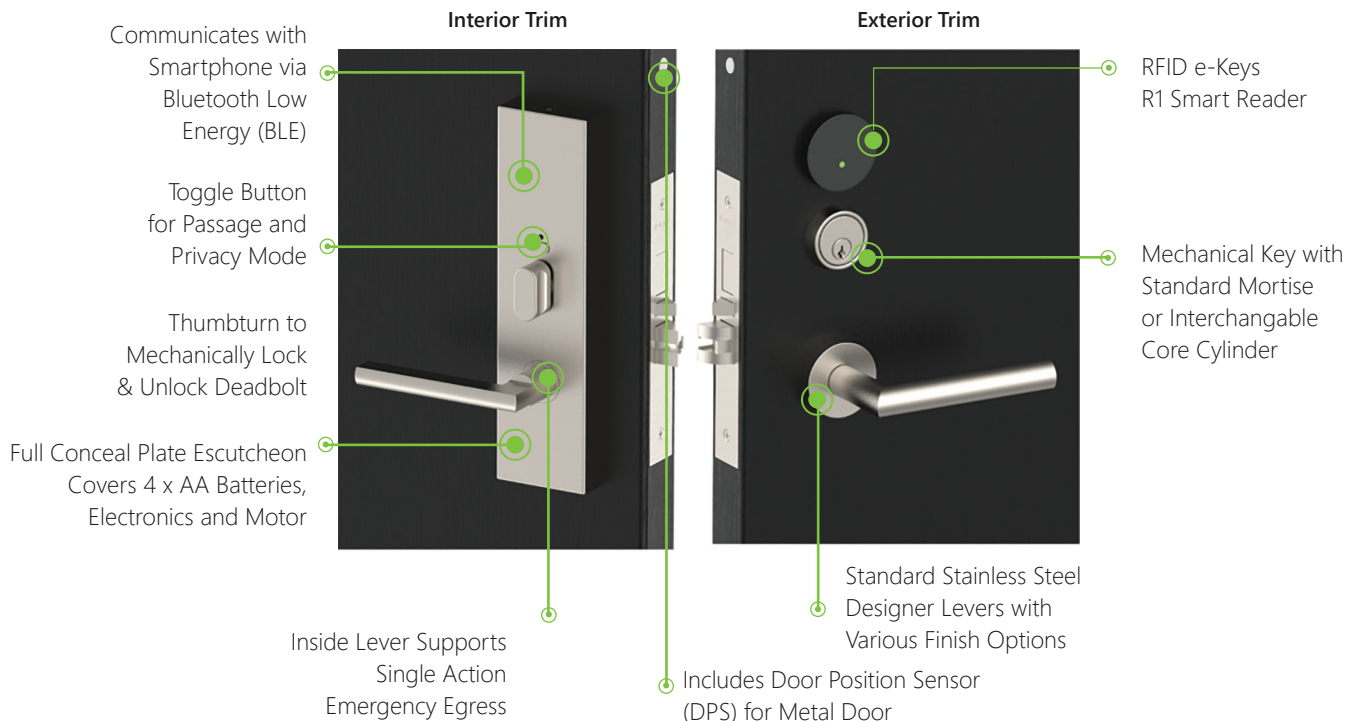

FUNCTIONS

- 

MC7438
Entrance without Toggle

 - Key or thumbturn controls deadbolt; lever operates latch.
 - Inside lever always allows exit; outside can be locked.
 - Auto-deadlocking with optional locked indicator.
- 

MC7050
Office and Inner Entry

 - Lever operates latch; outside can be locked by key or thumbturn.
 - When locked, key (outside) or inside lever retracts latch.
 - No deadbolt; auto-deadlocking latch with optional locked indicator.
- 

MC7080
Entry without Toggle, without Thumbturn

 - Functions as a Classroom Function — locking is achieved mechanically by key only; door may remain unlocked when desired
 - With auto-locking enabled via app, functions as a Storeroom Function — door remains locked at all times and can be unlocked only by key, RFID credential, or authorized app access.

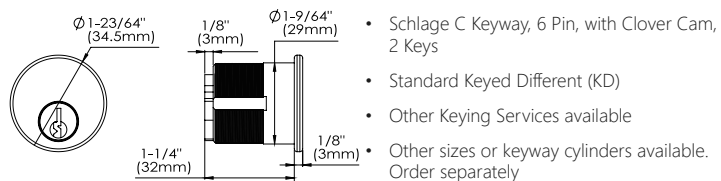

REPLACEMENT CYLINDERS & CORES



Standard Mortise Cylinder

- 

CMB1146

 - Mortise Cylinder, Schlage C Keyway, 6 pin, L Cam 1-1/4"
- 
 - EC-R460COL-FINISH Collar for Standard 1-1/4" Mortise Cylinder
- 
 - EC-R417COL-FINISH Extended Collar for 1-3/8" and 1-1/2" Mortise Cylinder

Standard SFIC & LFIC Housing

- 

CMB1146

 - Small Format Interchangeable Cylinder (SFIC) Housing 1-1/4", 6-Pin, Less Core, L Clover Cam
- CMB1387

 - Small Format Interchangeable Cylinder (SFIC) Housing 1-3/8", 7-Pin, Less Core, L Clover Cam
- CMB1126

 - Large Format Interchangeable Cylinder (LFIC) Housing 1-1/2", 6-Pin, Less Core, L Clover Cam

Interchangeable Cores

- 

SFIC 6

 - CMB-ICBA6-CMB - SFIC 6 Pin Core
- SFIC 7

 - CMB-ICBA7-CMB - SFIC 7 Pin Core

DIMENSIONS

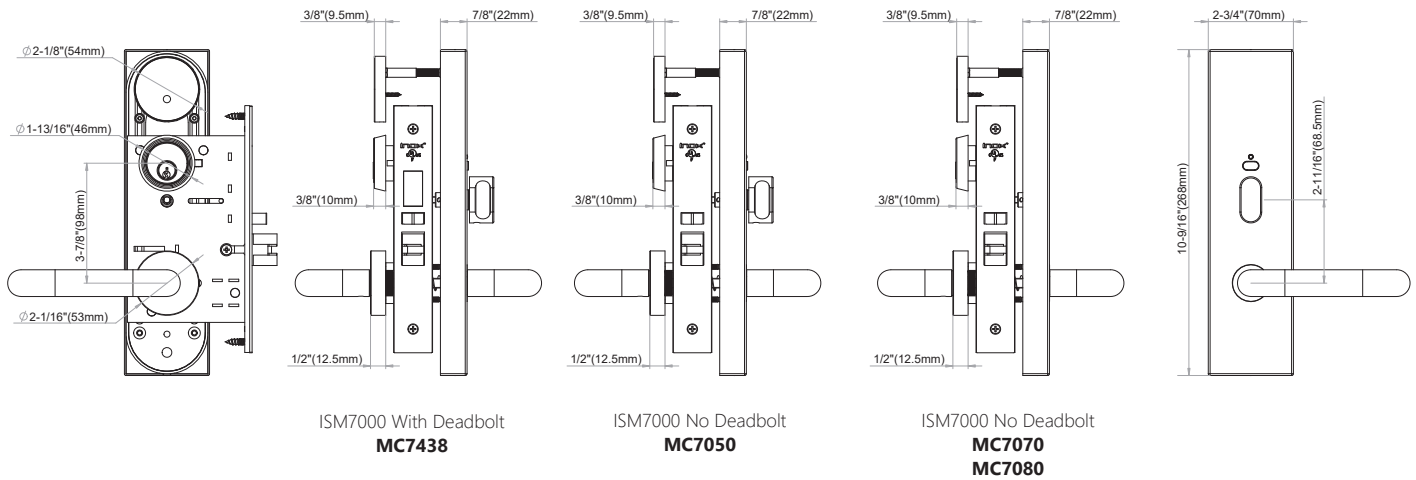





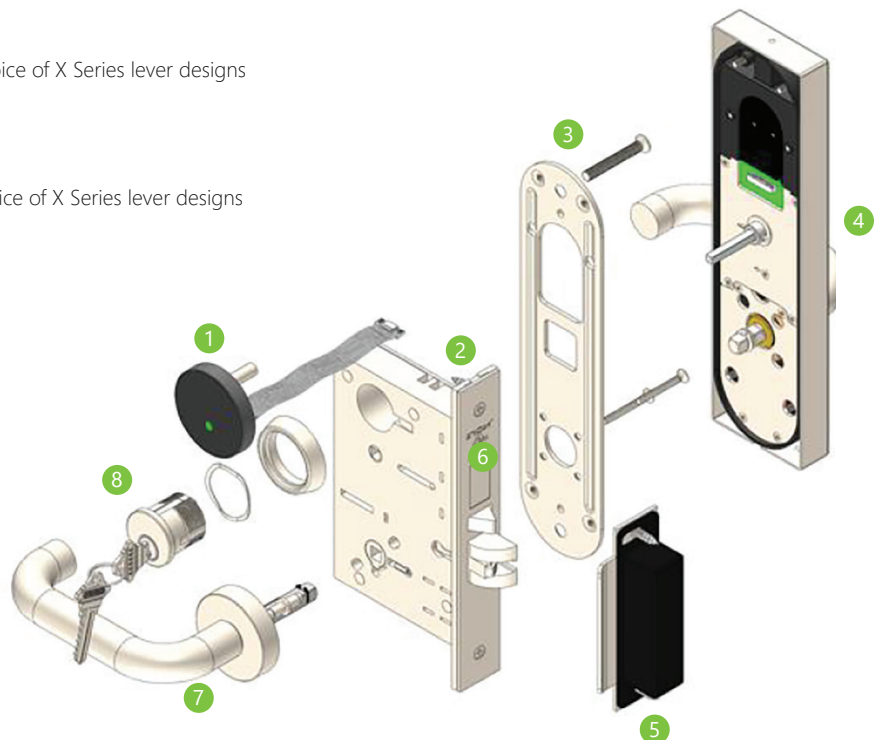













COMPONENTS

- 1 Bluetooth and RFID R1 Round Smart Reader
- 2 MC7000 Lockcase and Faceplate; 2-3/4" backset
- 3 Interior sub-plate
- 4 Interior heavy-duty stainless steel cast plate with choice of X Series lever designs
- 5 Commercial Mortise Lock Strike 4-7/8" x 1-7/8"
- 6 1" (25.4mm) heavy-duty deadbolt
- 7 Exterior heavy-duty stainless steel cast rose with choice of X Series lever designs
- 8 Schlage C keyway, 6 pin 1-1/4" mortise cylinder



HOW TO ORDER

Use the sequence below to create an item code for ordering. Please see price book for parts or additional service upcharges.

PRODUCT	ROSE	PLATE	LEVER	LOCK	READER	BLUETOOTH	CYLINDER	THUMBTURN	FINISH	HANDING
ISM	-XGT	-SFR	202	-MC7438	-R1	-BWR	-S6		-32D	-LH
1	2	3	4	5	6		7	8	9	10
ROSE	PLATE	LEVER			LOCK					
 XGT	 SFK	 201	 202	 205	 221	 243				
 XGS		 244	 276	 318	 319	 320				
		 321	 328	 345	 346	 509				
									<ul style="list-style-type: none"> • MC7438 = Deadbolt Entry w/o Toggle • MC7050 = Entry w/o Toggle • MC7080 = Classroom Function w/o Toggle *When Autolocking is OFF Storeroom Function w/o Toggle *When Autolocking is On • MDP = Mortise Dummy Pair 	

7 CYLINDER AND HOUSING (INCLUDES COLLAR)

- LC = Less Cylinder
- Blank = Standard Mortise 1-1/4" Cylinder
- S6 = Small Format Interchangeable Cylinder (SFIC) Housing 1-1/4", 6-Pin, Less Core, L Clover Cam
- S7 = Small Format Interchangeable Cylinder (SFIC) Housing 1-3/8", 7-Pin, Less Core, L Clover Cam
- L6 = Large Format Interchangeable Cylinder (LFIC) Housing 1-1/2", 6-Pin, Less Core, L Clover Cam
- Order IC Cores and Thick Door Kits (TDKs) separately. (See Price Book)

6 READER

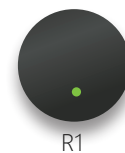

8 THUMBTURN



9 FINISHES* (STANDARD)

-  32D Satin Stainless Steel
-  32 Bright Stainless Steel
-  19G Graphite Black
-  PVD4 Satin Brass
-  Ceramax Graphite Black (C19G)
-  Ceramax Flat Black (C19)
-  Ceramax Stormy Grey (CGY)
-  Ceramax Dark Bronze (CDB)
-  Ceramax Burnt Bronze (CBB)

10 HANDING

- RH = Right Hand
- LH = Left Hand
- RHR = Right Hand Reverse
- LHR = Left Hand Reverse

*Please see Finish Solutions on INOX website for special order finishes.

LEVER DESIGN OPTIONS



201 COLOGNE
SHOWN AS
19G GRAPHITE BLACK



202 MUNICH
SHOWN AS
32D SATIN STAINLESS STEEL

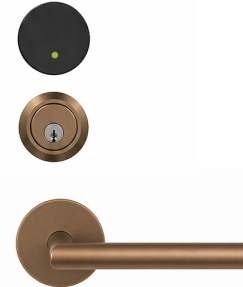

205 FRANKFURT
SHOWN AS
CERAMAX BURNT BRONZE

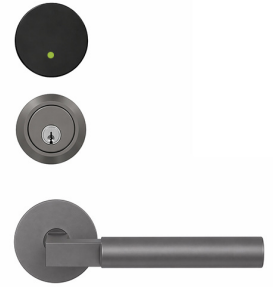

221 AURORA
SHOWN AS
CERAMAX STORMY GREY



243 SUNRISE
SHOWN AS
32D SATIN STAINLESS STEEL



244 TWILIGHT
SHOWN AS
CERAMAX DARK BRONZE

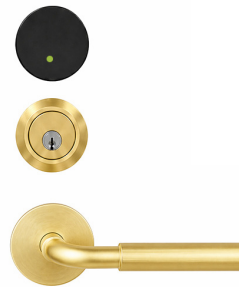

276 PLAZA
SHOWN AS
PVD4 SATIN BRASS



318 CAFE
SHOWN AS
CERAMAX FLAT BLACK (C19)



319 HAMPTON
SHOWN AS
CERAMAX GRAPHITE BLACK



320 EMPIRE
SHOWN AS
32 BRIGHT STAINLESS STEEL



321 VALENCIA
SHOWN AS
19G GRAPHITE BLACK



328 JAVA
SHOWN AS
32D SATIN STAINLESS STEEL

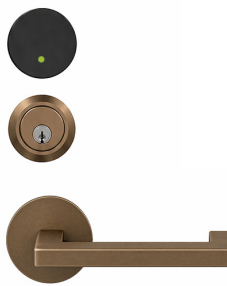

345 TOKYO
SHOWN AS
CERAMAX BURNT BRONZE



346 OSAKA
SHOWN AS
CERAMAX STORMY GREY



509 STUTTARD
SHOWN AS
32 BRIGHT STAINLESS STEEL



Smart Cylindrical Locks

SMART CYLINDRICAL

WITH KEYPAD

A commercial grade lock with built-in RFID reader and digital keypad offering smart access technology for residential and commercial entry doors in offices, multifamily and mixed use properties.



CODE COMPLIANCE

- UL Listed for 3 hour fire doors
- NFPA 80 National Fire Protection (Fire Door Assembly)
- ANSI A117.1 ADA Accessibility

FEATURES

- Grade 1 cylindrical lock with UL 3-hr fire-rated & 1/2" throw deadlatch that is completely reversible
- Available in 3 keying solutions: Standard 6 Pin Schlage C, 6 Pin SFIC A, or 6 Pin LFIC A Keyway
- Entry function with easily programmable Privacy and Passage modes
- Remote Access and Management via Wi-Fi and Bluetooth Low Energy
- Customizable permissions and levels for managing e-keys, users, and devices
- Standard exterior and interior gasket included, installation optional
- Compatible Door Position Sensor (DPS) for Metal included (Wood must be ordered separately)

FINISHES

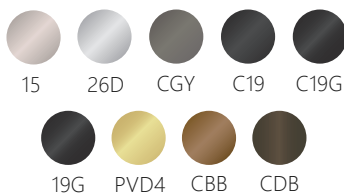

PRODUCT SERIES

ISC

SPECIFICATIONS

Door Thickness	1-3/4" (45mm) and 1-3/8" (35mm)
Door Prep	Crossbore: 2-1/8" (54mm) Edgebore: 1" (25mm)
	Latch face: 2-1/4" (57mm) x 1-1/8" (28.6mm)
Backset	2-3/4" (70mm) standard
Cylinder	6-pin anti-pick, solid brass cylinder
Keys	2 keys per lock, Schlage C keyway (IC Core and Keying Service available)
	6 Pin SFIC A Keyway or 6 Pin LFIC A Keyway
Handing	Non-handed
Latchbolt	1/2" (12.7mm) throw, Copper with nickel plating
Pin Length	4-8 digits
User Capacity	2000 Total (1000 RFID & 1000 Passcodes)
Temperature	-4 to 158°F (-20 to 70°C)
Keypad	Digital Touchscreen

FEATURED CALLOUTS

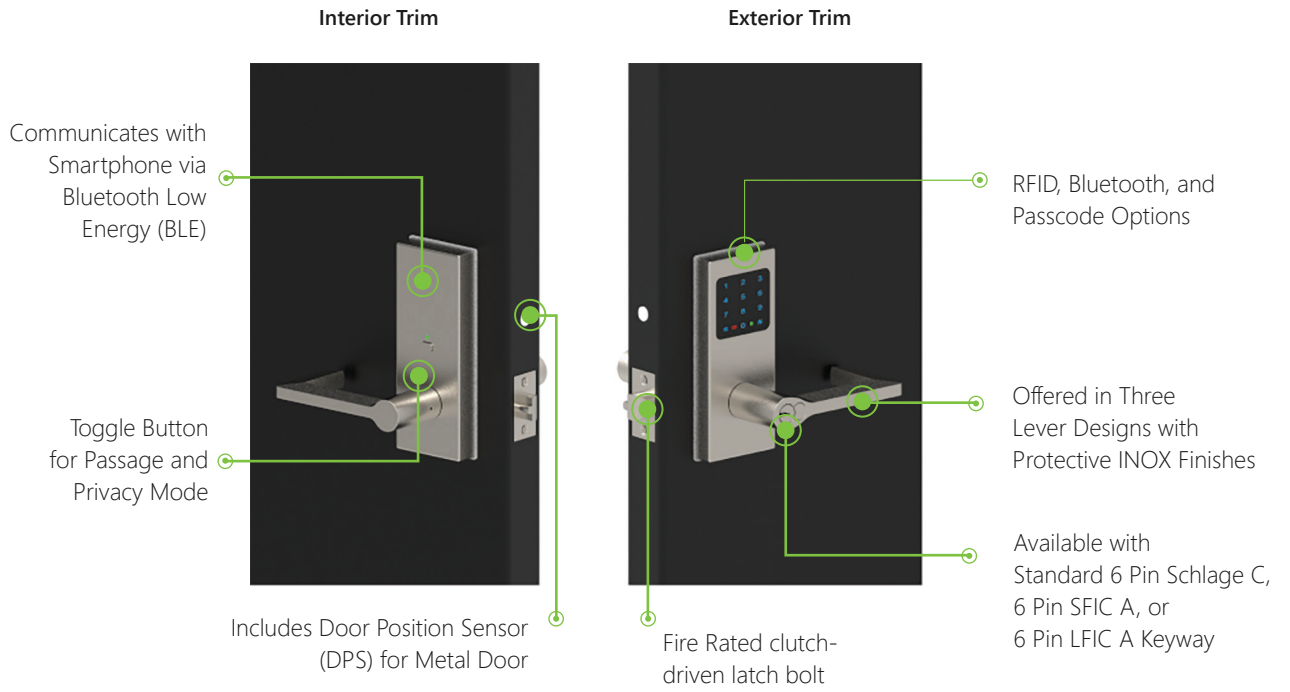

DIMENSIONS

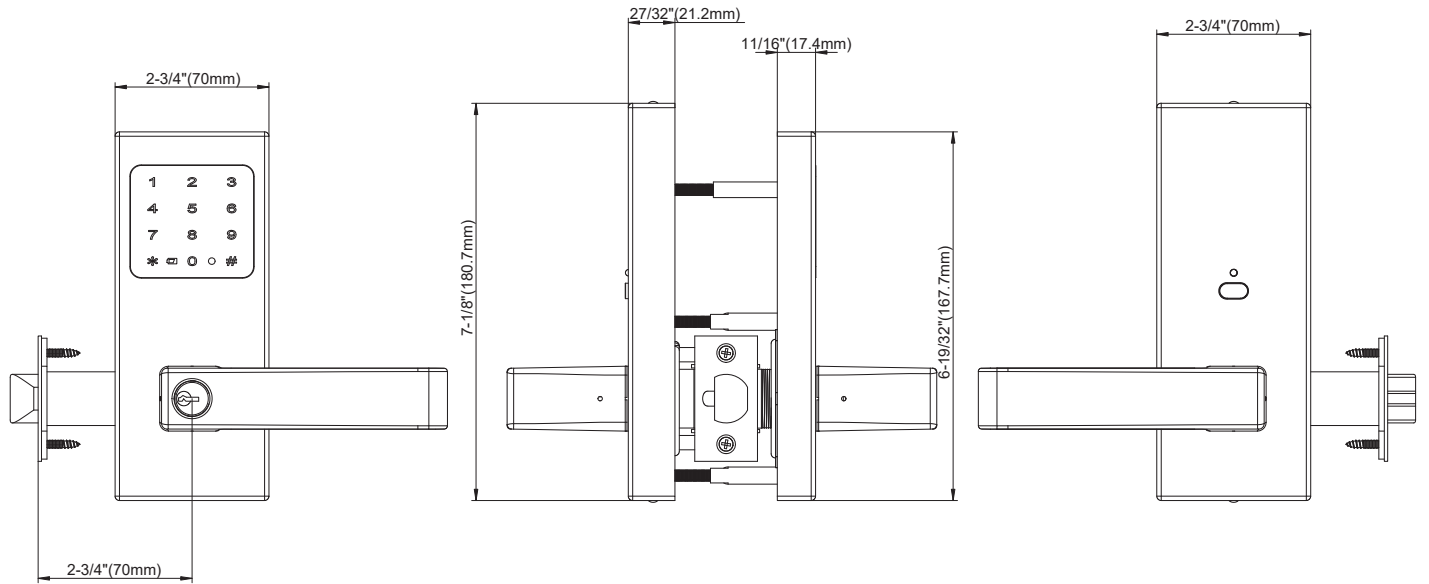

COMPONENTS

- 1 Touch-to-Lock Keypad
- 2 Dead Latch
- 3 Door Position Sensor Installation Optional
- 4 Interior Sub-Plate
- 5 SFIC 6-Pin Schlage C Key in Knob Cylinder with Tailpiece
- 6 Exterior Cover Plate
- 7 Standard ASA Strike for Latchbolt
- 8 Interior Cover Plate

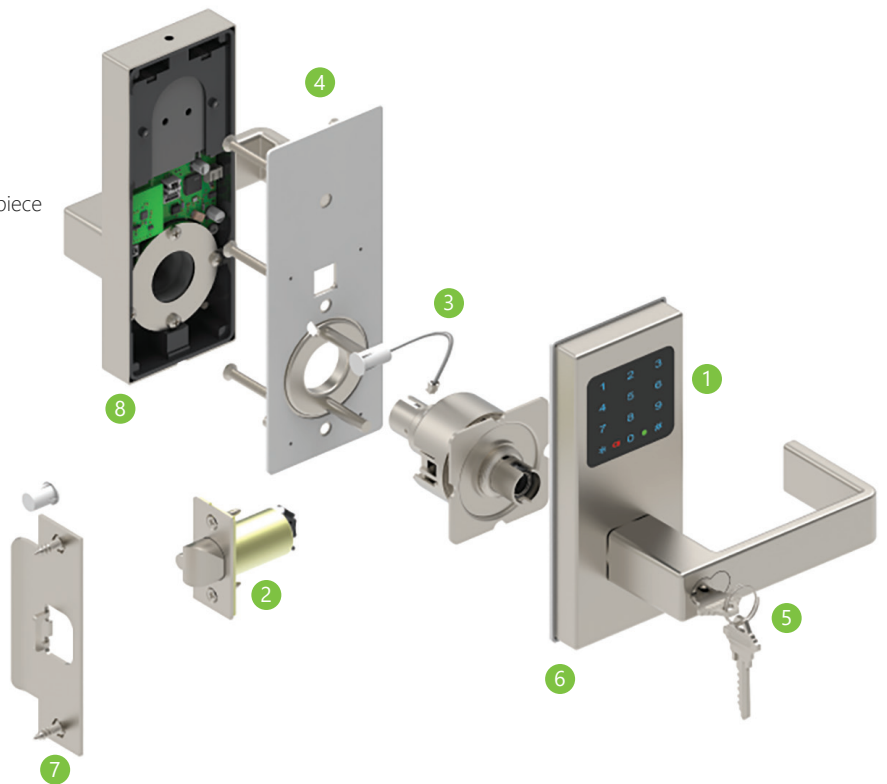

HOW TO ORDER

Use the sequence below to create an item code for ordering. Please see price book for parts or additional service upcharges.

PRODUCT	PLATE & LEVER	LOCK & FUNCTION	BACKSET	CYLINDER	FINISH
ISC	-HPK734	-CY6153	-B6		-26D
1	2	3	4	5	6



ESCUTCHEON
HPK = Escutcheon with Reader & Keypad

LEVERS

734 Kobe Lever



744 Halo Lever



749 Archer Lever



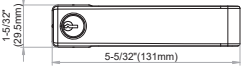
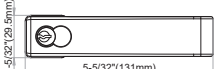
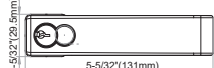
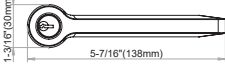
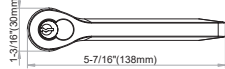
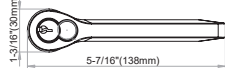
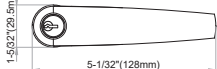
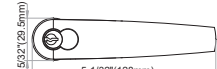
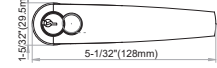



	Standard Cylinder	S6 SFIC Cylinder	L6 LFIC Cylinder
Standard Cylinder			
734 Kobe Lever			
744 Halo Lever			

* Interchangeable Cores Can be ordered separately

3 LOCK & FUNCTION

- CY6153 = CY Series, Entry

6 FINISHES* (STANDARD)

-  15 Satin Nickel
-  26D Satin Chrome
-  19G Graphite Black
-  PVD4 Satin Brass

4 BACKSET

- BLANK = 2-3/4" Backset
- B6 = 2-3/8" Backset

-  Cermax Graphite Black (C19G)
-  Cermax Flat Black (C19)
-  Cermax Stormy Grey (CGY)
-  Cermax Dark Bronze (CDB)
-  Cermax Burnt Bronze (CBB)

5 CYLINDER AND HOUSING

- Blank = Standard Cylinder
- S6 = Small Format Interchangeable 6-Pin Cylinder
- S7 = Small Format Interchangeable 7-Pin Cylinder
- L6 = Large Format interchangeable 6-Pin Cylinder

***Interchangeable Cores**



*Please see Finish Solutions on INOX website for special order finishes.

LEVER DESIGN OPTIONS



CERAMAX BURNT BRONZE



CERAMAX DARK BRONZE



CERAMAX FLAT BLACK (C19)



PVD4 SATIN BRASS



CERAMAX DARK BRONZE



CERAMAX GRAPHITE BLACK



15 SATIN NICKEL



26D SATIN CHROME



PVD4 SATIN BRASS



19G GRAPHITE BLACK



CERAMAX STORMY GREY



CERAMAX BURNT BRONZE

**All Exterior Trim Configurations above are shown in Right Hand (RH) Door Configuration*



Smart Deadbolt Locks

SMART DEADBOLT

WITH KEYPAD

A commercial grade lock with built-in RFID reader and digital keypad offering smart access technology for residential and light commercial applications where emergency egress is not required.



CODE COMPLIANCE

- UL Listed for 3 hour fire doors
- NFPA 80 National Fire Protection (Fire Door Assembly)
- ANSI A117.1 ADA Accessibility

FEATURES

- Designed to retrofit standard door prep of 2-1/8" bore holes with 2-3/8" or 2-3/4" backsets
- ANSI Grade 2 Fire-Rated Tapered Deadbolt built for indoor or outdoor use
- Solid Stainless Steel housing made of durable, corrosion-resistant body for long term use with reinforced anti-tamper bolt
- Illuminated touchpad for easy use in low-light conditions
- Motorized Deadbolt allows for smooth, quiet motion with auto-locking and capabilities
- Standard exterior and interior gasket included, installation optional
- Compatible Door Position Sensor (DPS) for Wood included (Metal must be ordered separately)

FINISHES

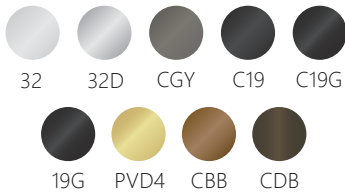

PRODUCT SERIES

ISD

SPECIFICATIONS

Door Thickness	1-3/4" (45mm) to 1-3/8" (35mm) Thick Door Kits available
Backset	2-3/8" (60mm) 2-3/4" (70mm)
Cylinder	1" RIM Cylinder (CRB105)
Keys	2 keys per lock, Schlage C keyway
Deadbolt	1" throw with hardened roller pin, UL 3 Hr Fire Rated Bolt Standard
Temperature	-4 to 158°F (-20 to 70°C)
Keypad	Digital Touchscreen

FEATURED CALLOUTS



DIMENSIONS

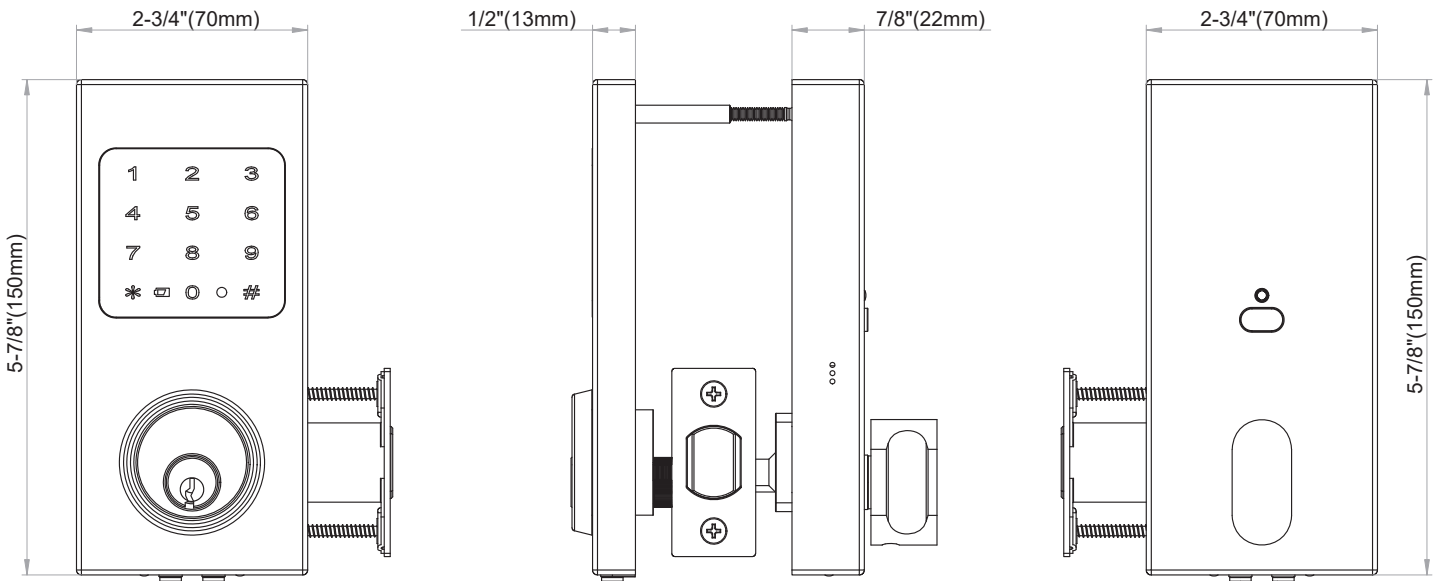

COMPONENTS

- 1 Touch-to-Lock Keypad
- 2 Deadbolt with Anti-Drill Pin
- 3 Door Position Sensor (DPS) (Installation Optional)
- 4 Interior Sub-Plate
- 5 Schlage C Keyway, 1" RIM Cylinder
- 6 6mm Collar
- 7 Exterior Cover Plate
- 8 Standard Strike for Bolt
- 9 Interior Cover Plate

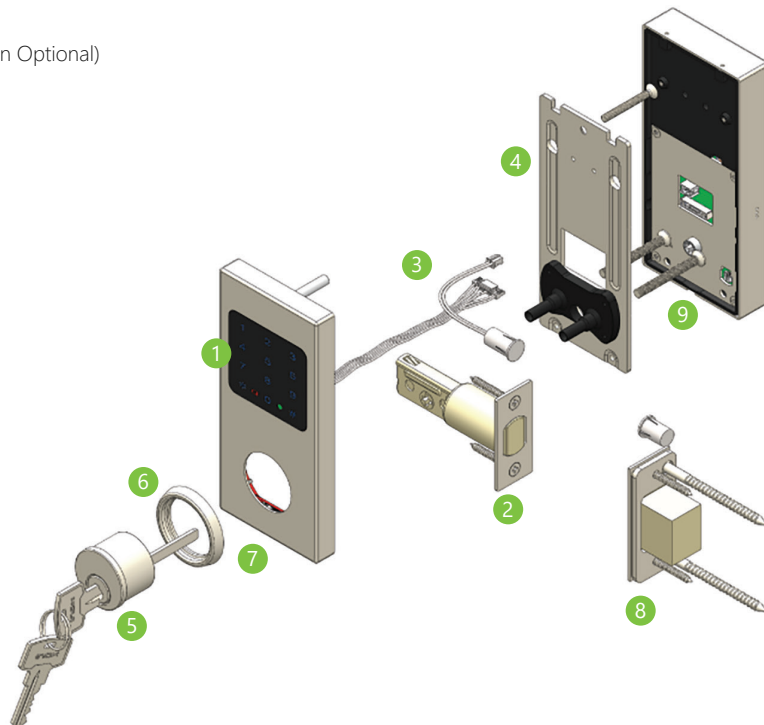

HOW TO ORDER

Use the sequence below to create an item code for ordering. Please see price book for parts or additional service upcharges.

PRODUCT	ESCUTCHEON	LOCK & FUNCTIONS	BACKSET	THUMBTURN	FINISH
ISD	-SHK	-BT110FT	-B6		-32D
1	2	3	4	5	6

THUMBTURN
SHK = SH Escutcheon with Reader & Keypad



3 LOCK & FUNCTION

- BT110F = Fire-Rated Tapered Deadbolt, Single Cylinder Function

4 BACKSET

- B6 = 2-3/8" Backset
- B7 = 2-3/4" Backset

5 THUMBTURN



6 FINISHES* (STANDARD)

- | | |
|---|---|
|  32D Satin Stainless Steel |  Ceramax Graphite Black (C19G) |
|  32 Bright Stainless Steel |  Ceramax Flat Black (C19) |
|  19G Graphite Black |  Ceramax Stormy Grey (CGY) |
|  PVD4 Satin Brass |  Ceramax Dark Bronze (CDB) |
| |  Ceramax Burnt Bronze (CBB) |

*Please see Finish Solutions on INOX website for special order finishes.

LEVER DESIGN OPTIONS



CERAMAX FLAT BLACK



CERAMAX BURNT BRONZE



19G GRAPHITE BLACK



CERAMAX DARK BRONZE



PVD4 SATIN BRASS



CERAMAX STORMY GREY



32D SATIN STAINLESS STEEL



32 BRIGHT STAINLESS STEEL



CERAMAX GRAPHITE BLACK

Smart Tubular Interconnect Locks



SMART TUBULAR INTERCONNECT

WITH KEYPAD

A commercial grade lock with built-in RFID reader and digital keypad offering smart access technology for residential and commercial entry doors in offices, multifamily and mixed use properties.



CODE COMPLIANCE

- UL Listed for 3 hour fire doors
- CAN/ULC S104 up to 3 hours
- UBC Standard 7-2 (1997) NFPA 252
- NFPA 80 National Fire Protection (Fire Door Assembly)
- NFPA101 National Fire Protection
- ANSI A117.1 ADA Accessibility

FINISHES

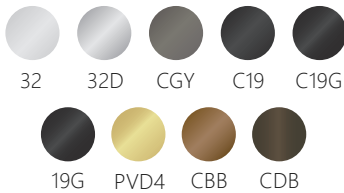

PRODUCT SERIES

IST

FEATURES

- BHMA/ANSI Grade 2, UL 3-hr fire-rated TL4 latch and fire-rated tapered bolt
- The interconnect design combines the added security of a tubular deadbolt with single action egress
- Available in 4" and 5.5" center-to-center door prep and installation with motorized deadbolt and touch-to-lock keypad
- Backend IoT PaaS complies with domestic and international information security standards, privacy, and compliance requirements
- Standard exterior and interior gasket included, installation optional
- Compatible Door Position Sensor (DPS) for Metal included with sticker (Wood must be ordered separately)

SPECIFICATIONS

Door Thickness	1-3/4" (45mm) Thick door kits available
Backset	2-3/8" (60mm) 2-3/4" (70mm)
Center Distance	4" (101mm) 5-1/2" (133mm)
Handing	Specify handing for all functions; latchbolt is field reversible
Hub & Spindle	5/16" (8mm) square
Latch Faceplate	1" x 2-1/4" standard square corner
Cylinder	1" RIM Cylinder, 2 keys included, keying service available
Keypad	Digital Touchscreen

FEATURED CALLOUTS

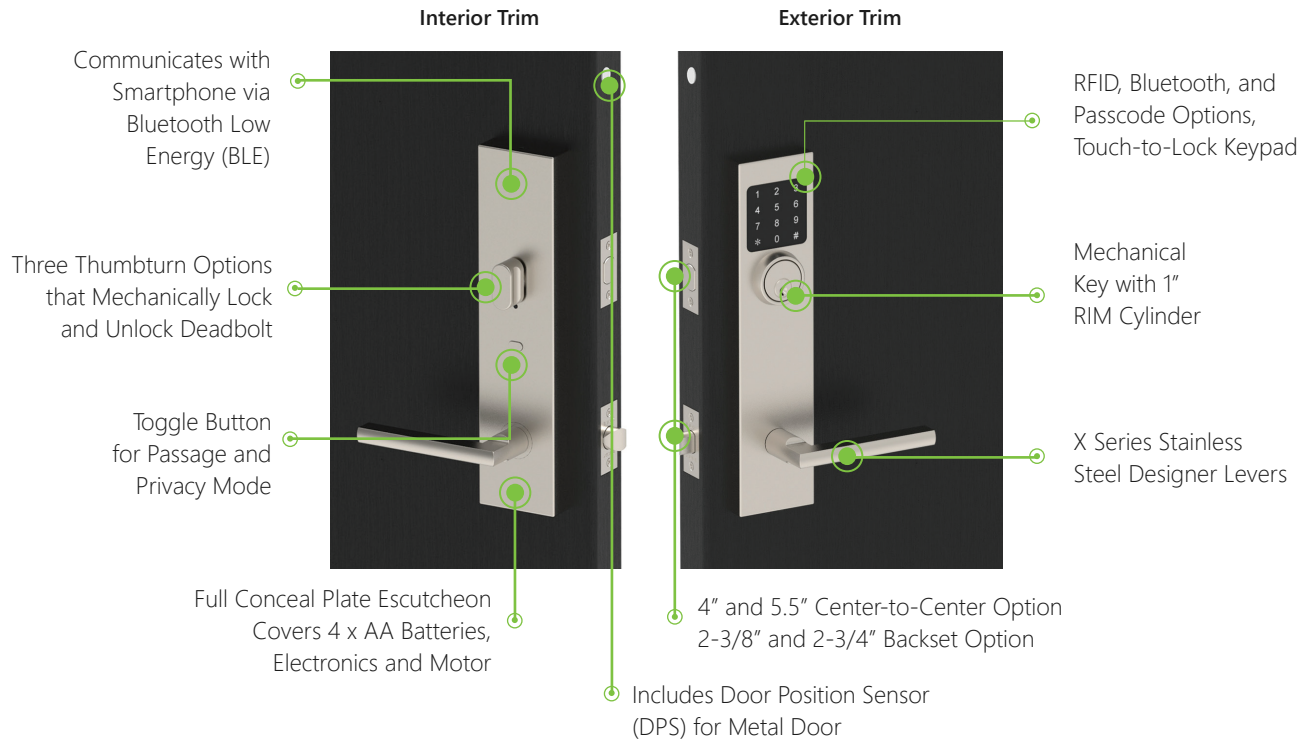

DIMENSIONS

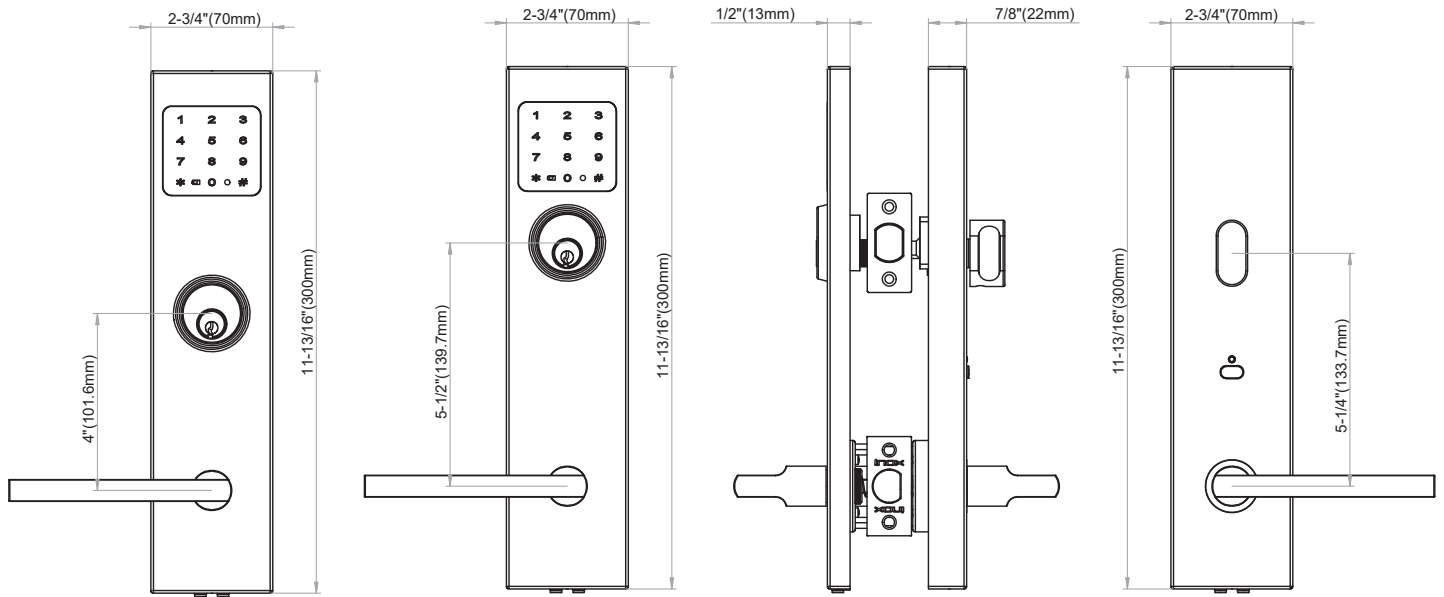

COMPONENTS

- 1 Touch-to-Lock Keypad
- 2 Deadbolt with Anti-Drill Pin
- 3 Door Position Sensor (DPS) (Installation Optional)
- 4 Interior Sub-Plate
- 5 Schlage C Keyway, 1" RIM Cylinder
- 6 6mm Collar
- 7 Exterior heavy-duty stainless steel cast plate with choice of X Series lever designs
- 8 TL4 Latch
- 9 Standard Strike for Latch and Bolt
- 10 Interior heavy-duty stainless steel cast plate with choice of X Series lever designs

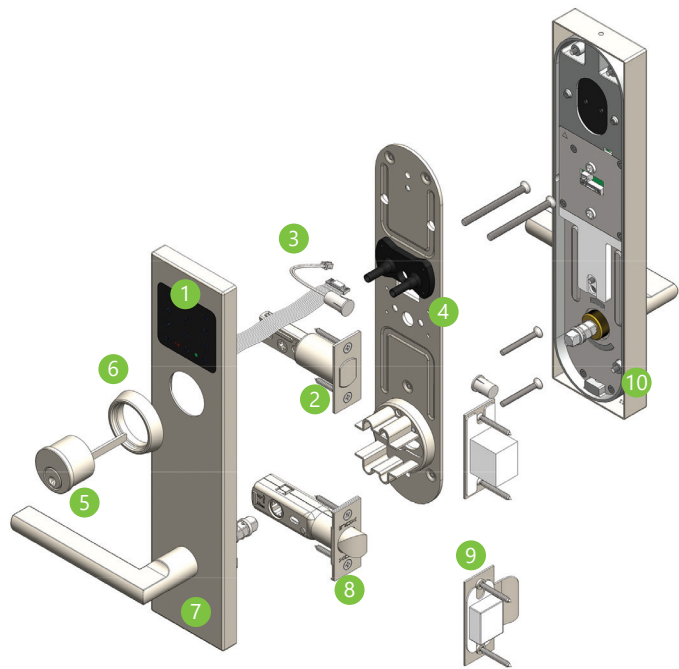

HOW TO ORDER

Use the sequence below to create an item code for ordering. Please see price book for parts or additional service upcharges.

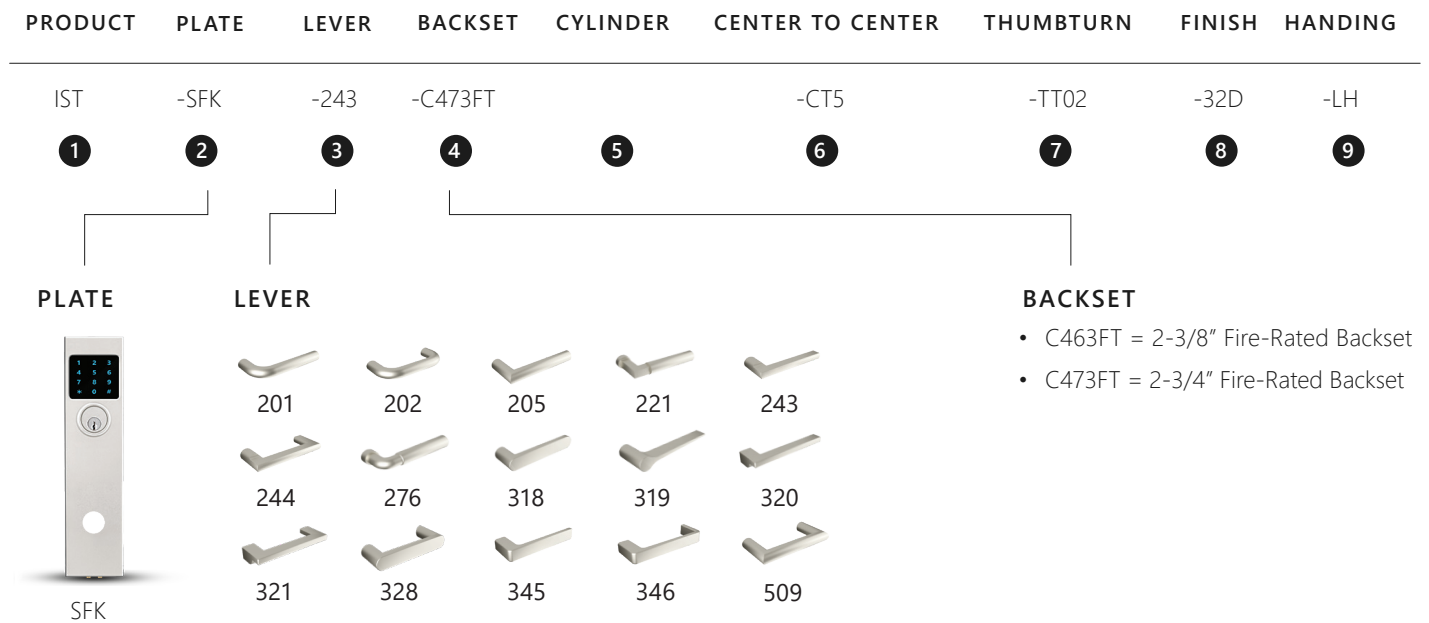

5 CYLINDER AND HOUSING (INCLUDES COLLAR)

- LC = Less Cylinder
- Blank = Standard Mortise 1-1/4" Cylinder

6 CENTER TO CENTER

- CT4 = 4" Center to Center
- CT5 = 5-1/2" Center to Center

8 FINISHES* (STANDARD)

- | | | | |
|---|---------------------------|---|-------------------------------|
|  | 32D Satin Stainless Steel |  | Ceramax Graphite Black (C19G) |
|  | 32 Bright Stainless Steel |  | Ceramax Flat Black (C19) |
|  | 19G Graphite Black |  | Ceramax Stormy Grey (CGY) |
|  | PVD4 Satin Brass |  | Ceramax Dark Bronze (CDB) |
| | |  | Ceramax Burnt Bronze (CBB) |

*Please see Finish Solutions on INOX website for special order finishes.

7 THUMBTURN



9 HANDING

- RH = Right Hand
- LH = Left Hand
- RHR = Right Hand Reverse
- LHR = Left Hand Reverse

LEVER DESIGN OPTIONS



201 COLOGNE
SHOWN AS
19G GRAPHITE BLACK



202 MUNICH
SHOWN AS
32D SATIN STAINLESS STEEL



205 FRANKFURT
SHOWN AS
CERAMAX BURNT BRONZE



221 AURORA
SHOWN AS
CERAMAX STORMY GREY



243 SUNRISE
SHOWN AS
32D SATIN STAINLESS STEEL



244 TWILIGHT
SHOWN AS
CERAMAX DARK BRONZE



276 PLAZA
SHOWN AS
PVD4 SATIN BRASS



318 CAFE
SHOWN AS
CERAMAX FLAT BLACK (C19)



319 HAMPTON
SHOWN AS
CERAMAX GRAPHITE BLACK



320 EMPIRE
SHOWN AS
32 BRIGHT STAINLESS STEEL



321 VALENCIA
SHOWN AS
19G GRAPHITE BLACK



328 JAVA
SHOWN AS
32D SATIN STAINLESS STEEL



345 TOKYO
SHOWN AS
CERAMAX BURNT BRONZE



346 OSAKA
SHOWN AS
CERAMAX STORMY GREY



509 STUTTGARD
SHOWN AS
32 BRIGHT STAINLESS STEEL

**All Exterior Trim Configurations above are shown in Right Hand (RH) Door Configuration*

SMART SECTIONAL INTERCONNECT

WITH KEYPAD

A commercial grade lock with built-in RFID reader and digital keypad offering smart access technology for residential and commercial entry doors in offices, multifamily and mixed use properties.



FEATURES

- Unique single design with both 4" center-to-center and 5.5" center-to-center applications
- Simplifies lock retrofits by eliminating door replacement in many instances
- Offers both 2-3/4" and 2-3/8" backsets for maximum door prep compatibility
- Battery powered (4 x AA alkaline) with 9V emergency power access
- Motor-driven deadbolt enables auto-locking functionality
- Inside lever egress simultaneously retracts both deadbolt and latch, ensuring fast and secure exit
- Standard exterior and interior gasket included, installation optional
- Compatible Door Position Sensor (DPS) for Metal included (Wood must be ordered separately)

CODE COMPLIANCE

- UL Listed for 3 hour fire doors
- CAN/ULC S104 up to 3 hours
- UBC Standard 7-2 (1997) NFPA 252
- NFPA 80 National Fire Protection (Fire Door Assembly)
- NFPA101 National Fire Protection
- ANSI A117.1 ADA Accessibility

FINISHES

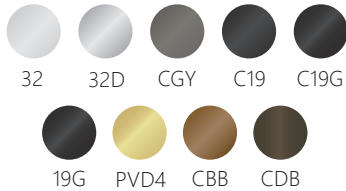

SPECIFICATIONS

Door Thickness	1-3/4" (45mm) Thick door kits available
Backset	2-3/8" (60mm) standard 2-3/4" (70mm) optional
Center Distance	4" (101mm) 5-1/2" (133mm)
Handing	Specify handing for all functions; latchbolt is field reversible
Hub & Spindle	5/16" (8mm) square
Latch Faceplate	1" x 2-1/4" standard square corner
Cylinder	1" RIM Cylinder, 2 keys included, Keying service available
Keypad	Digital Touchscreen

PRODUCT SERIES

IST-K1

FEATURED CALLOUTS



DIMENSIONS

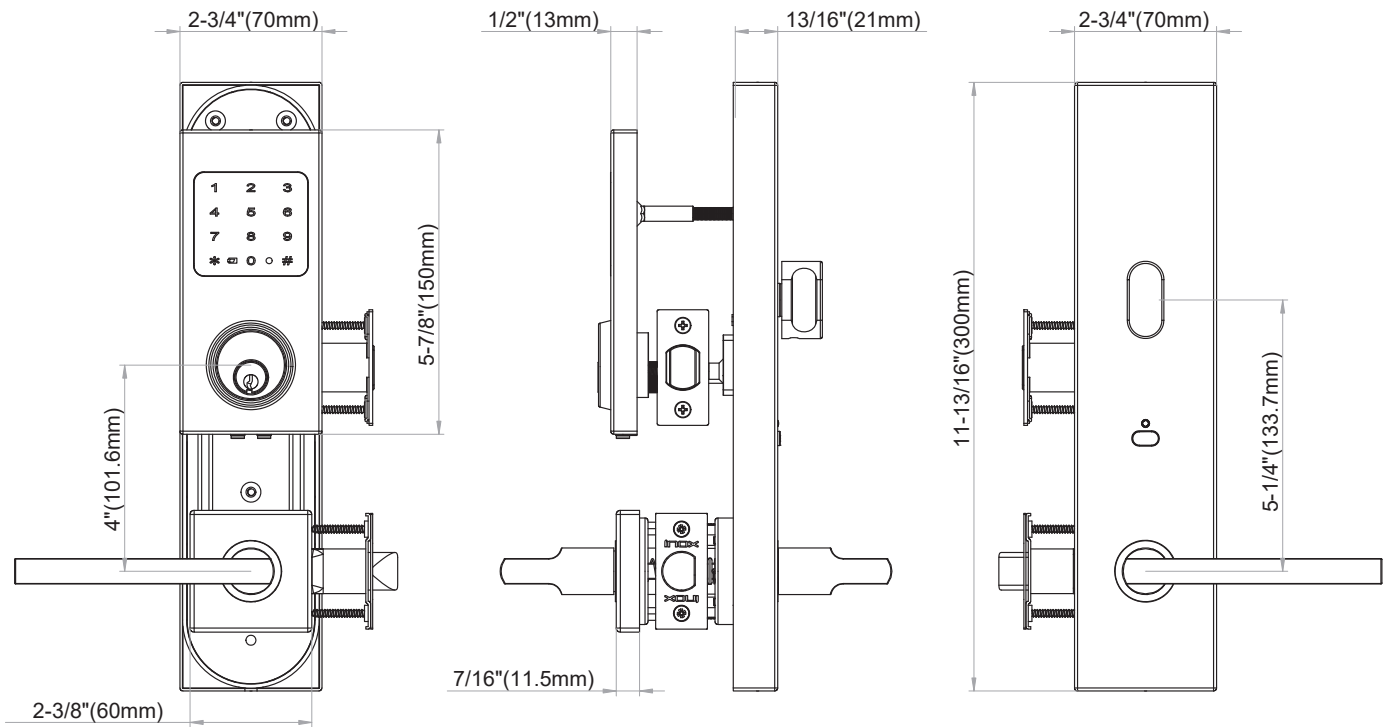

COMPONENTS

- 1 Touch-to-Lock Keypad
- 2 Deadbolt with anti-drill pin
- 3 DPS - Door Position Sensor (Installation Optional)
- 4 Tubular Interior Sub-Plate
- 5 Schlage C keyway, 1" RIM Cylinder
- 6 6mm Collar
- 7 Exterior heavy-duty stainless steel cast plate with choice of X Series lever designs
- 8 TL4 Latch
- 9 Standard Strike for Latch and Bolt
- 10 Interior heavy-duty stainless steel cast plate with choice of X Series lever designs

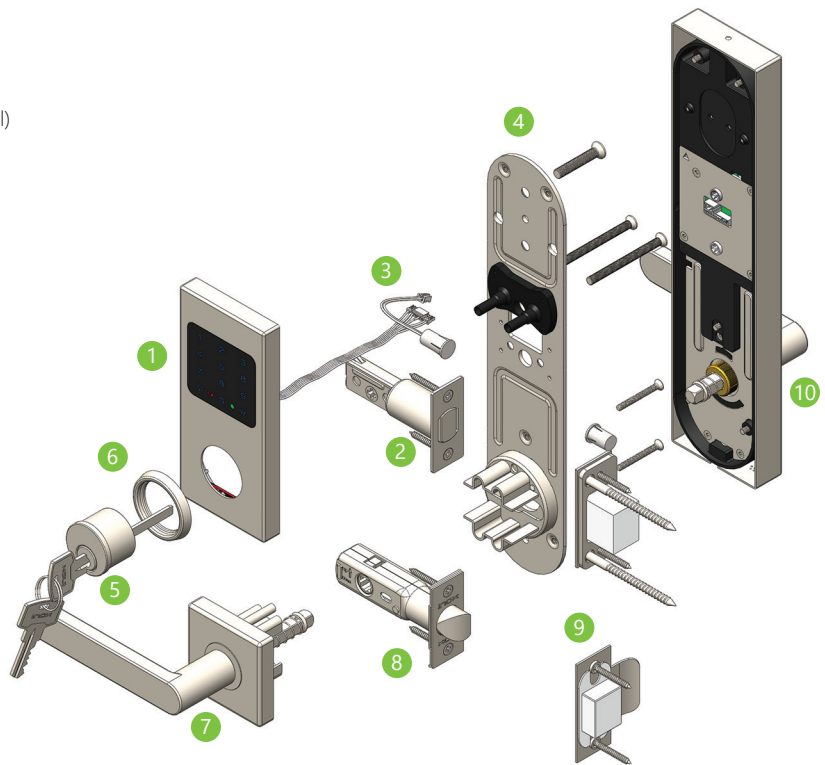

LEVER DESIGN OPTIONS



201 COLOGNE
SHOWN AS
19G GRAPHITE BLACK



202 MUNICH
SHOWN AS
32D SATIN STAINLESS STEEL

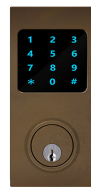

205 FRANKFURT
SHOWN AS
CERAMAX BURNT BRONZE



221 AURORA
SHOWN AS
CERAMAX STORMY GREY



243 SUNRISE
SHOWN AS
32D SATIN STAINLESS STEEL



244 TWILIGHT
SHOWN AS
CERAMAX DARK BRONZE



276 PLAZA
SHOWN AS
PVD4 SATIN BRASS



318 CAFE
SHOWN AS
CERAMAX FLAT BLACK (C19)



319 HAMPTON
SHOWN AS
CERAMAX GRAPHITE BLACK



320 EMPIRE
SHOWN AS
32 BRIGHT STAINLESS STEEL



321 VALENCIA
SHOWN AS
19G GRAPHITE BLACK



328 JAVA
SHOWN AS
32D SATIN STAINLESS STEEL



345 TOKYO
SHOWN AS
CERAMAX BURNT BRONZE



346 OSAKA
SHOWN AS
CERAMAX STORMY GREY



509 STUTTGARD
SHOWN AS
32 BRIGHT STAINLESS STEEL

**All Exterior Trim Configurations above are shown in Right Hand (RH) Door Configuration*





Smart Tubular Handlesets

SMART TUBULAR

ENTRY HANDLESET

The INOX App paired with our smart Touch-to-Lock keypad manages multiple users and properties with real-time access control to provide enhanced security and convenience.



CODE COMPLIANCE

- UL Listed for 3 hour fire doors
- CAN/ULC S104 up to 3 hours
- UBC Standard 7-2 (1997) NFPA 252
- NFPA 80 National Fire Protection (Fire Door Assembly)
- NFPA101 National Fire Protection
- ANSI A117.1 ADA Accessibility

FINISHES

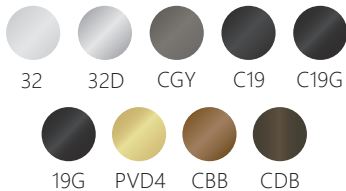

PRODUCT SERIES

ISTH-BWK

FEATURES

- BHMA/ANSI Grade 2, UL 3-hr fire-rated TL5 latch and fire-rated tapered bolt
- Elegant full plate handleset design featuring sturdy pull handle and backlit keypad
- Use the INOX Smart App to manage users, track access, and customize settings remotely from your smartphone
- Set timed auto-locking and activate Privacy Mode for added security
- Weather-resistant stainless steel construction (effective when used with separate weather seals)
- Standard interior gasket included, installation optional
- Compatible Door Position Sensor (DPS) for Metal included (Wood must be ordered separately)

SPECIFICATIONS

Door Thickness	1-3/4" (45mm) Standard Thick Door Kit available
Backset	2-3/8" (60mm) 2-3/4" (70mm)
Center-to-Center Distance	Lever to Cylinder: 5-1/2" (140mm)
Cylinder	1" RIM Cylinder (CRB105) 5-pin Schlage C Keyway with 2 keys

FEATURED CALLOUTS

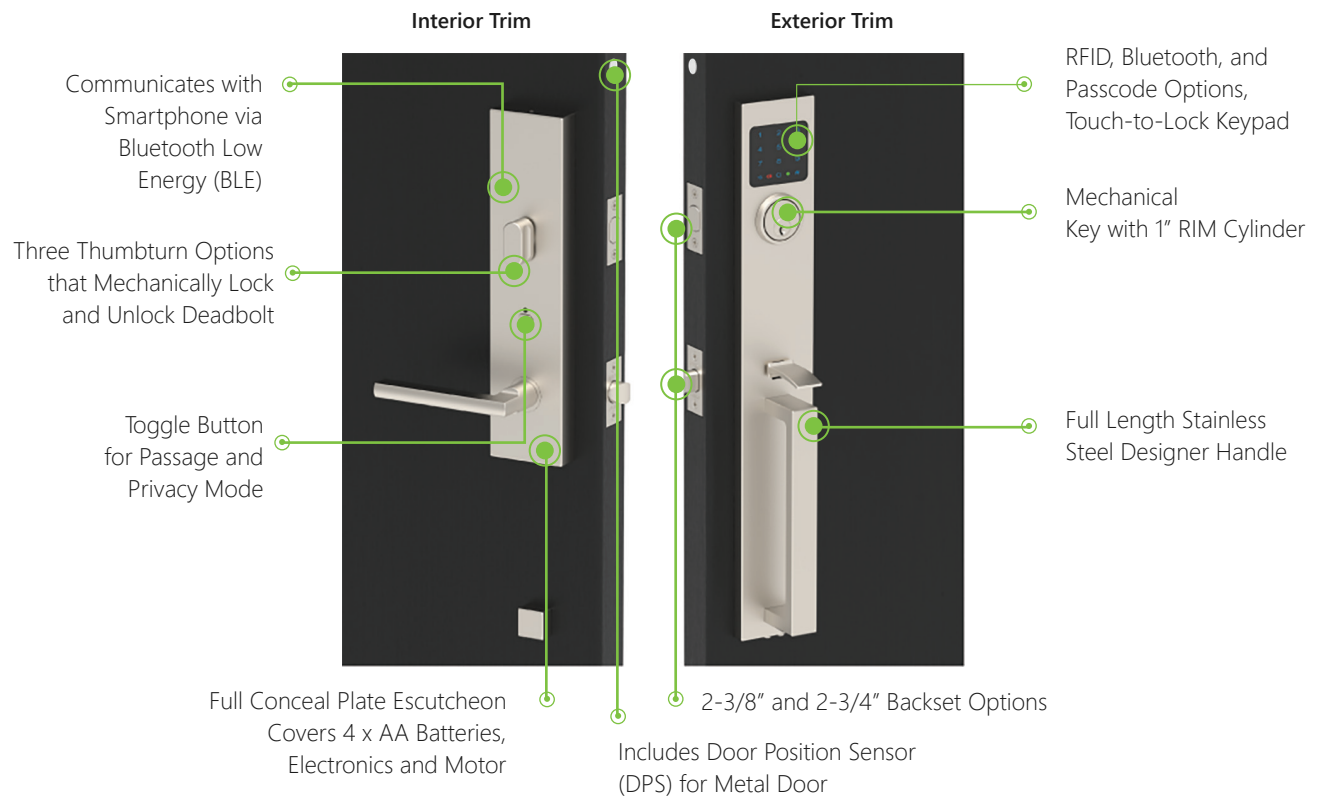

DIMENSIONS

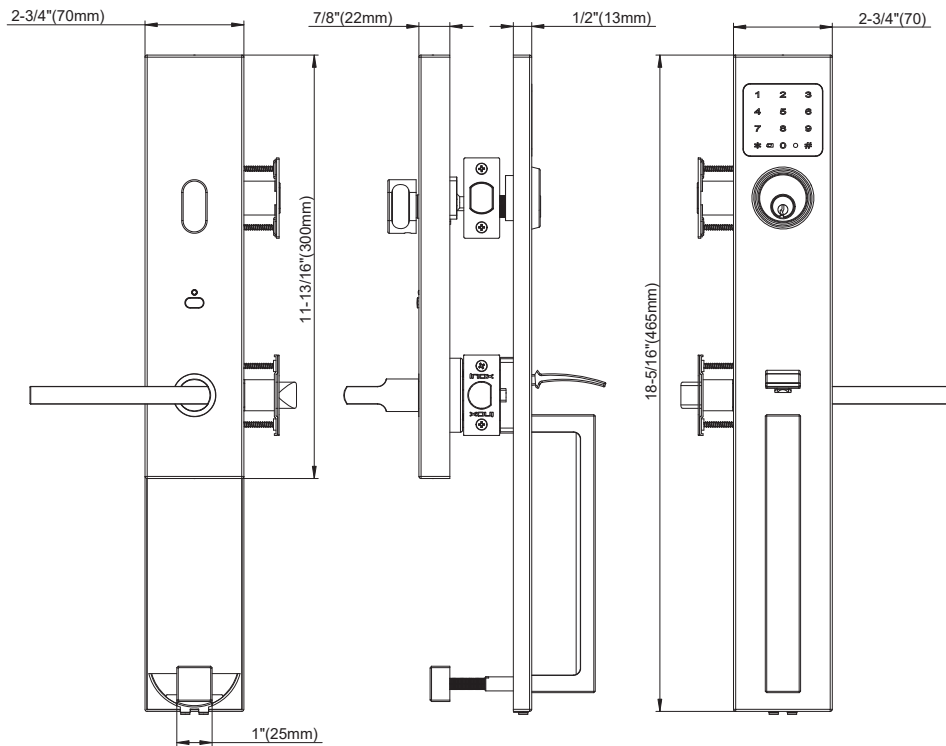

COMPONENTS

- 1 Touch-to-Lock Keypad
- 2 Deadbolt with anti-drill pin
- 3 DPS - Door Position Sensor (Installation Optional)
- 4 Tubular Interior Sub-Plate
- 5 Schlage C keyway, 1" RIM Cylinder
- 6 6mm Collar
- 7 Exterior heavy-duty stainless steel cast plate with sturdy Pull Handle
- 8 TL5 Latch
- 9 Standard Strike for Latch and Bolt
- 10 Interior heavy-duty stainless steel cast plate with choice of X Series lever designs
- 11 Interior bolt that connects to the Exterior plate

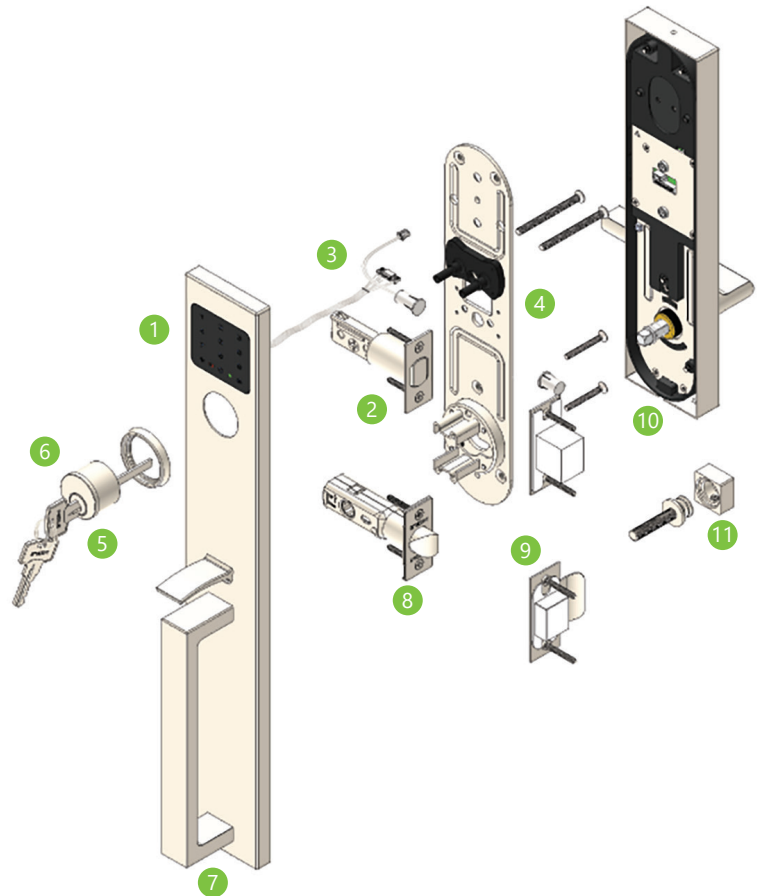

HOW TO ORDER

Use the sequence below to create an item code for ordering. Please see price book for parts or additional service upcharges.

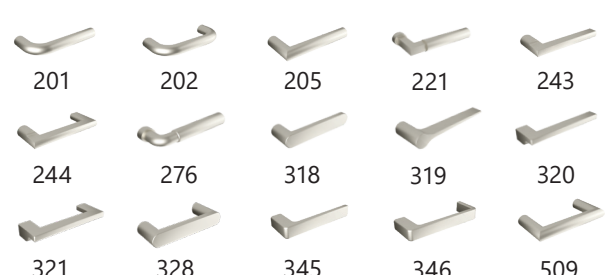
PRODUCT	HANDLESET	LEVER	BACKSET	CENTER-TO-CENTER	CYLINDER	THUMBTURN	FINISH	HANDING
ISTH	-BWK	243	-C573FT	-CT5		-TT02	-32D	-LH
1	2	3	4	5	6	7	8	9
HANDLESET		LEVER			BACKSET			
					<ul style="list-style-type: none"> • C563FT = 2-3/8" Backset (Fire Rated Latch) • C573FT = 2-3/4" Backset (Fire Rated Latch) 			
SFK		201 202 205 221 243 244 276 318 319 320 321 328 345 346 509						

5 CENTER TO CENTER

- CT4 = 4" Center to Center
- CT5 = 5-1/2" Center to Center

6 CYLINDER AND HOUSING (INCLUDES COLLAR)

- LC = Less Cylinder
- Blank = Standard 1" RIM Cylinder

7 THUMBTURN



8 FINISHES* (STANDARD)

- | | | | |
|---|---------------------------|--|-------------------------------|
|  | 32D Satin Stainless Steel |  | Ceramax Graphite Black (C19G) |
|  | 32 Bright Stainless Steel |  | Ceramax Flat Black (C19) |
|  | 19G Graphite Black |  | Ceramax Stormy Grey (CGY) |
|  | PVD4 Satin Brass |  | Ceramax Dark Bronze (CDB) |
| | |  | Ceramax Burnt Bronze (CBB) |

9 HANDING

- RH = Right Hand
- LH = Left Hand
- RHR = Right Hand Reverse
- LHR = Left Hand Reverse

*Please see Finish Solutions on INOX website for special order finishes.

LEVER DESIGN OPTIONS



201 COLOGNE
SHOWN AS
19G GRAPHITE BLACK



202 MUNICH
SHOWN AS
32D SATIN STAINLESS STEEL



205 FRANKFURT
SHOWN AS
CERAMAX BURNT BRONZE



221 AURORA
SHOWN AS
CERAMAX STORMY GREY



243 SUNRISE
SHOWN AS
32D SATIN STAINLESS STEEL



244 TWILIGHT
SHOWN AS
CERAMAX DARK BRONZE



276 PLAZA
SHOWN AS
PVD4 SATIN BRASS



318 CAFE
SHOWN AS
CERAMAX FLAT BLACK (C19)

**All Trim Configurations above are shown in Left Hand (LH) Door Configuration*

LEVER DESIGN OPTIONS

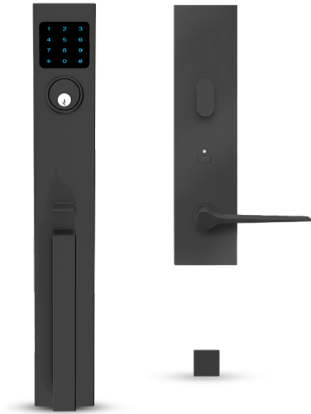

319 HAMPTON
SHOWN AS
CERAMAX GRAPHITE BLACK



320 EMPIRE
SHOWN AS
32 BRIGHT STAINLESS STEEL

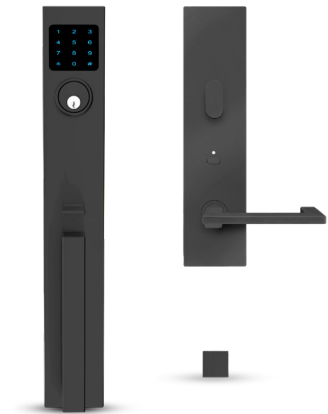

321 VALENCIA
SHOWN AS
19G GRAPHITE BLACK



328 JAVA
SHOWN AS
32D SATIN STAINLESS STEEL



345 TOKYO
SHOWN AS
CERAMAX BURNT BRONZE



346 OSAKA
SHOWN AS
CERAMAX STORMY GREY



509 STUTTGARD
SHOWN AS
32D SATIN STAINLESS STEEL

**All Trim Configurations above are shown in Left Hand (LH) Door Configuration*

SMART TUBULAR

ENTRY HANDLESET

The INOX App paired with our smart Touch-to-Lock keypad, manages multiple users and properties with real-time access control to provide enhanced security and convenience.



CODE COMPLIANCE

- ANSI/BHMA Grade 2
- UL Listed for 3 hour fire doors
- NFPA 80 National Fire Protection (Fire Door Assembly)

FEATURES

- BHMA/ANSI Grade 2, UL 3-hr fire-rated TL5 latch and fire-rated tapered bolt
- Elegant 3-Piece Handleset design featuring sturdy Pull Handle and Backlit Keypad
- Use the INOX Smart App to manage users, track access, and customize settings remotely from your smartphone
- Set timed auto-locking and activate Privacy Mode for added security
- Standard exterior and interior gasket included, installation optional
- Compatible Door Position Sensor (DPS) for Metal included (Wood must be ordered separately)

FINISHES

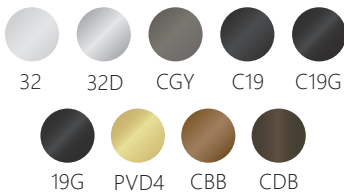

PRODUCT SERIES

ISTH-HUK

SPECIFICATIONS

Door Thickness	1-3/4" (45mm) Standard Thick Door Kit available
Backset	2-3/8" (60mm) 2-3/4" (70mm)
Center-to-Center Distance	Lever to Cylinder: 5-1/2" (140mm)
Cylinder	1" RIM Cylinder (CRB105) 5-pin Schlage C Keyway with 2 keys

SMART TUBULAR ENTRY HANDLESET

FEATURED CALLOUTS

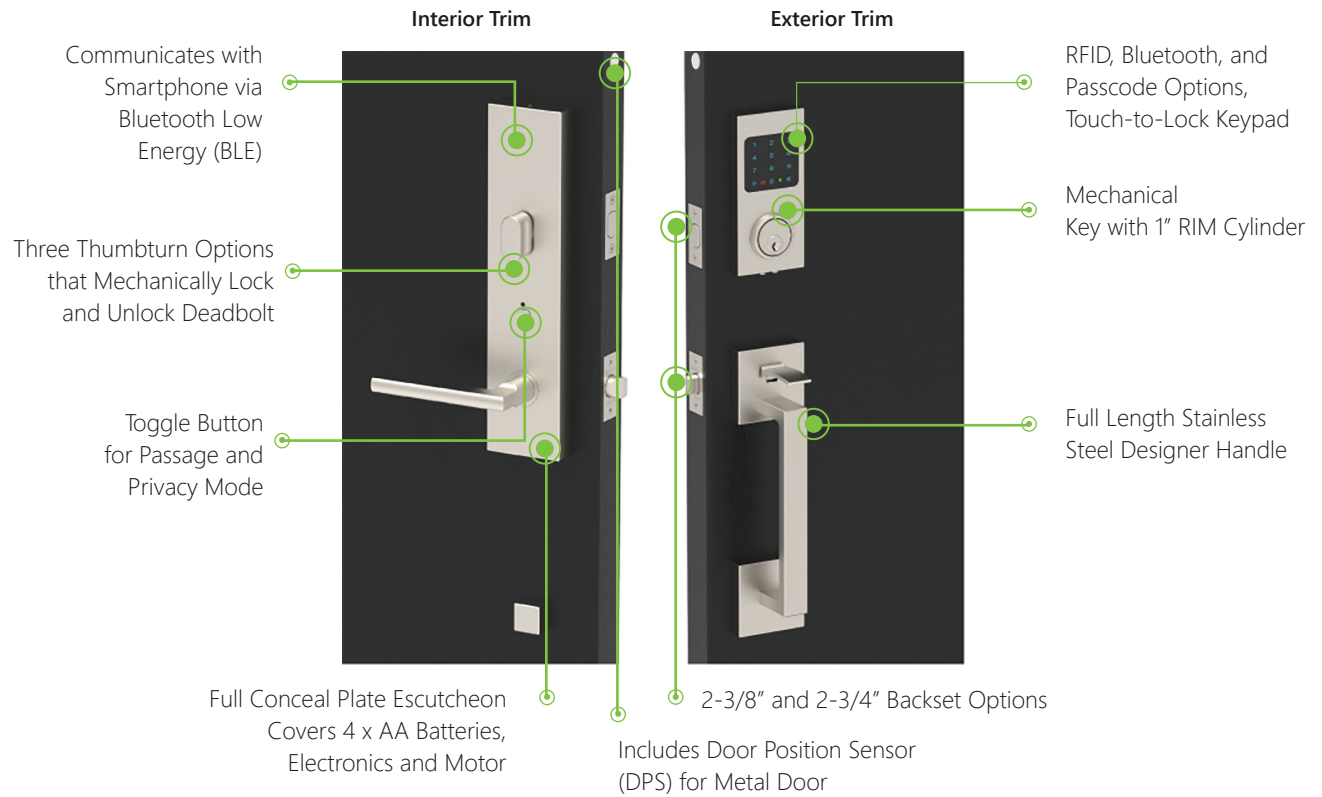

DIMENSIONS

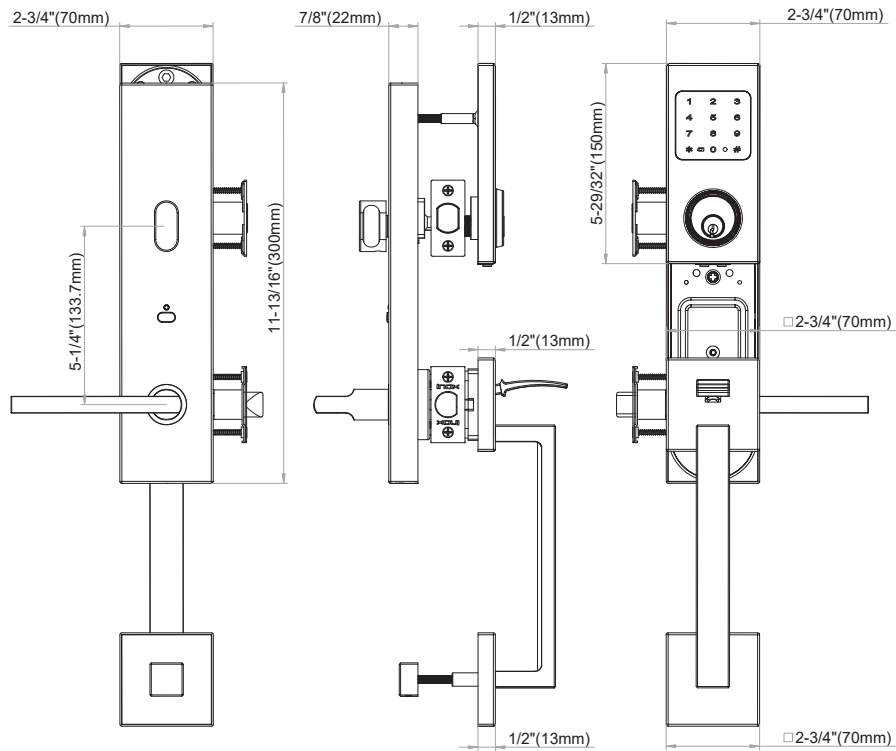





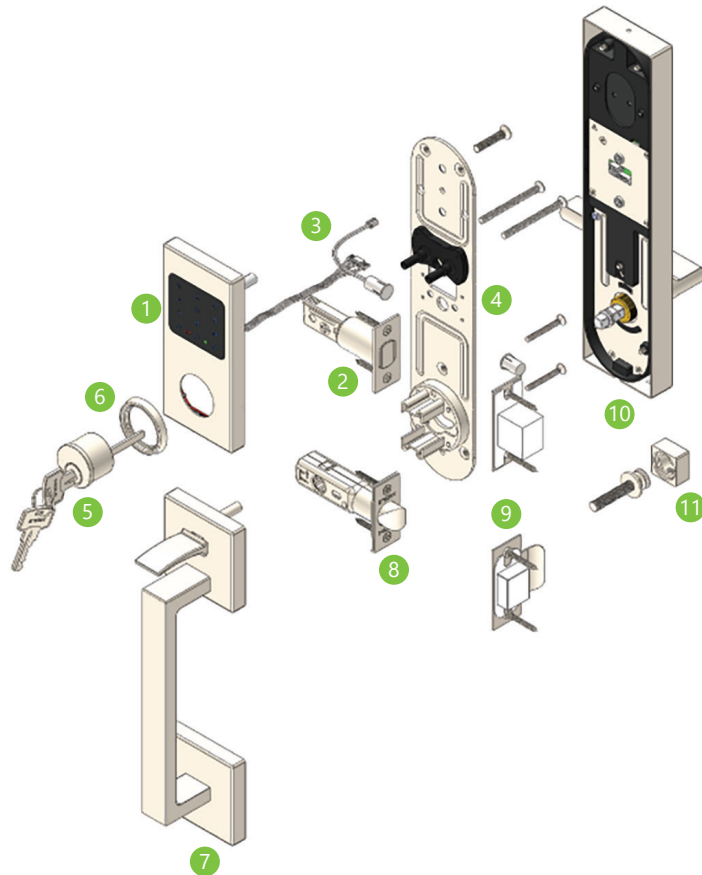









COMPONENTS

- 1 Touch-to-Lock Keypad
- 2 Deadbolt with anti-drill pin
- 3 DPS - Door Position Sensor (Installation Optional)
- 4 Tubular Interior Sub-Plate
- 5 Schlage C keyway, 1" RIM Cylinder
- 6 6mm Collar
- 7 Exterior heavy-duty stainless steel cast plate with sturdy Pull Handle
- 8 TL5 Latch
- 9 Standard Strike for Latch and Bolt
- 10 Interior heavy-duty stainless steel cast plate with choice of X Series lever designs
- 11 Thru-bolt Escutcheon



HOW TO ORDER

Use the sequence below to create an item code for ordering. Please see price book for parts or additional service upcharges.

PRODUCT	PLATE	LEVER	BACKSET	CENTER-TO-CENTER	CYLINDER	THUMBTURN	FINISH	HANDING		
ISTH	-HUK	243	-C573FT	-CT5		-TT02	-32D	-LH		
1	2	3	4	5	6	7	8	9		
PLATE		LEVER			BACKSET					
 <p>ISD PULL</p>		 201  244  321	 202  276  328	 205  318  345	 221  319  346	 243  320  509	<ul style="list-style-type: none"> • C563FT = 2-3/8" Backset (Fire Rated Latch) • C573FT = 2-3/4" Backset (Fire Rated Latch) 			

5 CENTER TO CENTER

- CT5 = 5-1/2" Center-to-Center

6 CYLINDER AND HOUSING (INCLUDES COLLAR)

- LC = Less Cylinder
- Blank = Standard 1" RIM Cylinder

7 THUMBTURN



8 FINISHES* (STANDARD)



9 HANDING

- RH = Right Hand
- LH = Left Hand
- RHR = Right Hand Reverse
- LHR = Left Hand Reverse

*Please see Finish Solutions on INOX website for special order finishes.

LEVER DESIGN OPTION

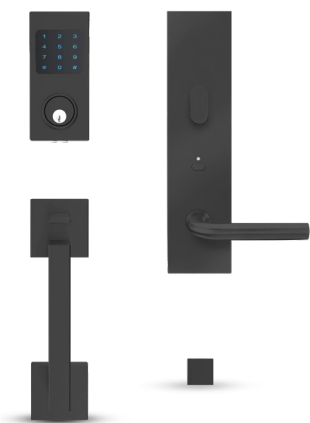

201 COLOGNE
SHOWN AS
19G GRAPHITE BLACK



202 MUNICH
SHOWN AS
32D SATIN STAINLESS STEEL



205 FRANKFURT
SHOWN AS
CERAMAX BURNT BRONZE

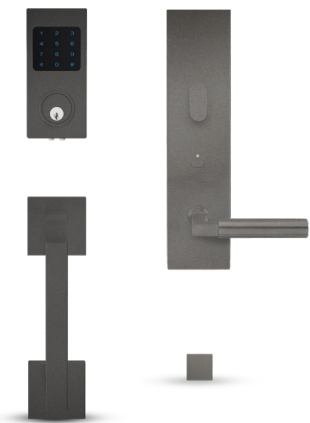

221 AURORA
SHOWN AS
CERAMAX STORMY GREY



243 SUNRISE
SHOWN AS
32D SATIN STAINLESS STEEL

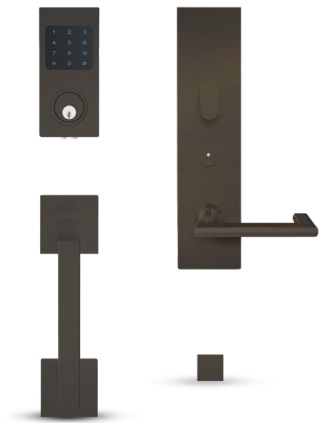

244 TWILIGHT
SHOWN AS
CERAMAX DARK BRONZE



276 PLAZA
SHOWN AS
PVD4 SATIN BRASS



318 CAFE
SHOWN AS
CERAMAX FLAT BLACK (C19)

**All Trim Configurations above are shown in Left Hand (LH) Door Configuration*

LEVER DESIGN OPTIONS

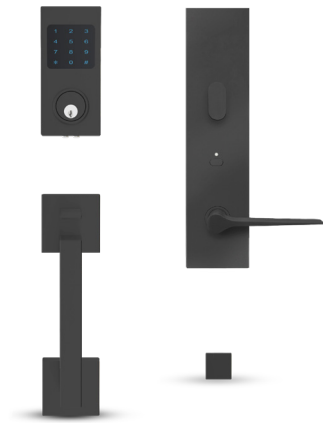

319 HAMPTON
SHOWN AS
CERAMAX GRAPHITE BLACK



320 EMPIRE
SHOWN AS
32D SATIN STAINLESS STEEL

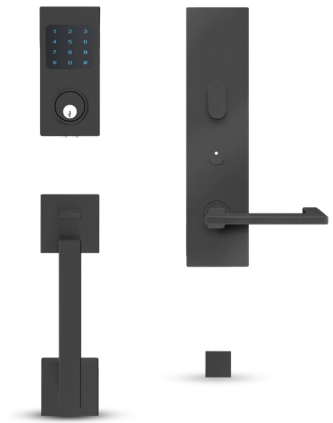

321 VALENCIA
SHOWN AS
19G GRAPHITE BLACK



328 JAVA
SHOWN AS
32D SATIN STAINLESS STEEL

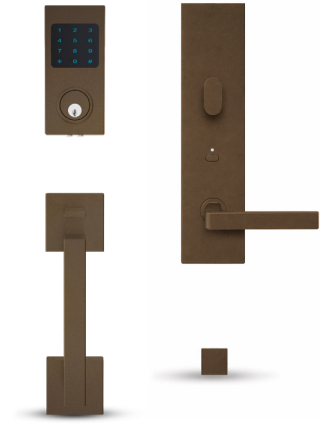

345 TOKYO
SHOWN AS
CERAMAX BURNT BRONZE

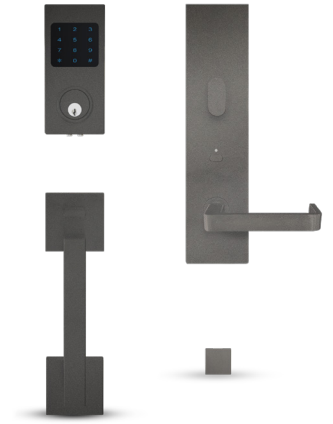

346 OSAKA
SHOWN AS
CERAMAX STORMY GREY



509 STUTTARD
SHOWN AS
32D SATIN STAINLESS STEEL

**All Trim Configurations above are shown in Left Hand (LH) Door Configuration*





Smart Sliding Door Locks

SMART SLIDING DOOR LOCK

SECTIONAL WITH KEYPAD

The perfect smart keypad solution across a variety of applications, including commercial, mixed use, multi-tenant offices, and commercial/retail facilities.



CODE COMPLIANCE

- ANSI/BHMA 156.36 Auxiliary Locks
- ABSU A117.1 Accessibility Code
- (ADA Compliant)
- Backend IoT PaaS complies with domestic and international information security standards, privacy, and compliance requirements
- Backend IoT PaaS security covers data and cloud services

FINISHES

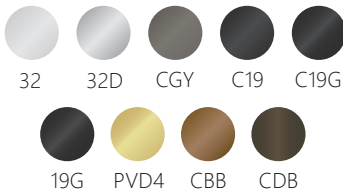

PRODUCT SERIES

ISM-PD95-K1

FEATURES

- Smart Mortise Lock that can be remotely locked, unlocked, and programmed from anywhere in the world
- Offers property owners and managers a platform to create an all-inclusive access management hub with unlimited properties, openings, and users
- Standard exterior and interior gasket included, installation optional
- Compatible Door Position Sensor (DPS) for Metal included (Wood must be ordered separately)

SPECIFICATIONS

Door Thickness	1-3/4" (45mm) Standard
Backset	2-3/4" (70mm)
	2-1/2" (63.5mm)
Center-to-Center Distance	Lever to Cylinder: 3-7/8" (98mm)
	Lever to Thumbturn: 2-11/16" (68mm)
Cylinder	Schlage C keyway 6 pin
	1-1/4" mortise cylinder w/ 2 keys (standard)
	Optional SFIC and LFIC housing and cores available
CAM	CAM01-SCL Clover Cam
Material	Trim: Stainless Steel Lockcase: Heavy Gauge Steel
	Deadbolt: Stainless Steel Cylinder: Solid Brass
	Faceplate/Strike: Stainless Steel

SMART SLIDING DOOR LOCK SECTIONAL WITH KEYPAD

FEATURED CALLOUTS



SURFACE PULLS



PHIX31108



PHIX330.512.8



PHIX41714



PHIX45714



PHIX30108

DIMENSIONS

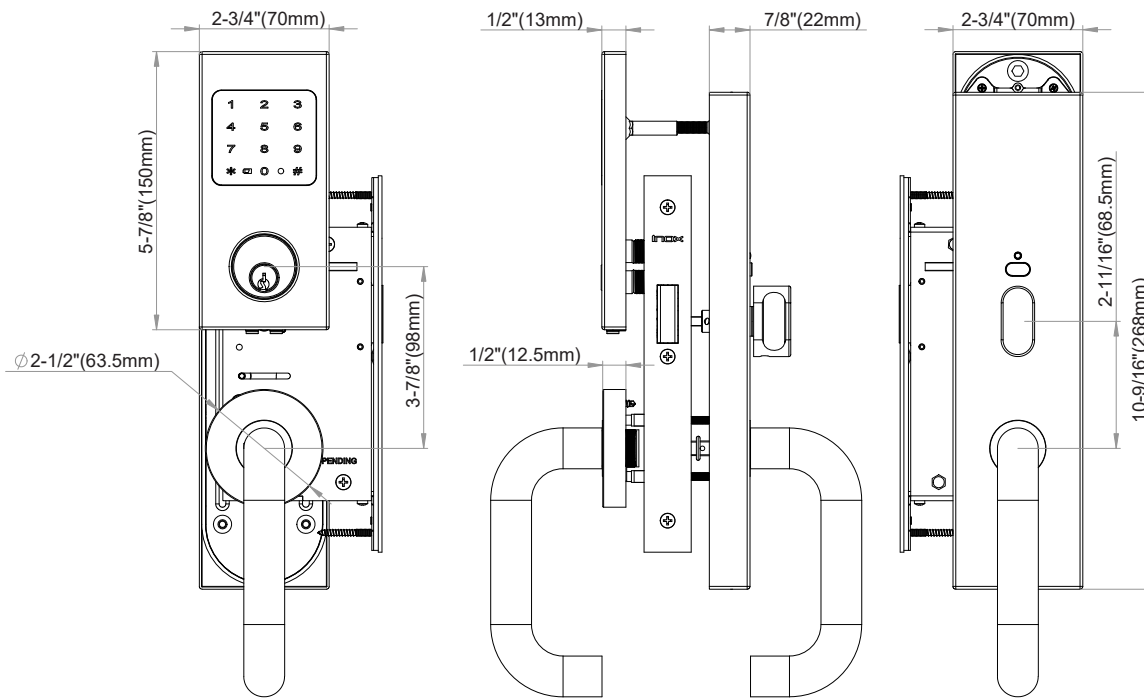



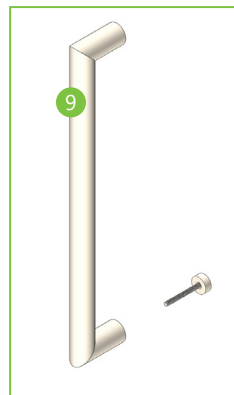
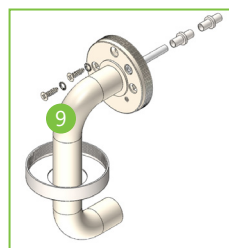
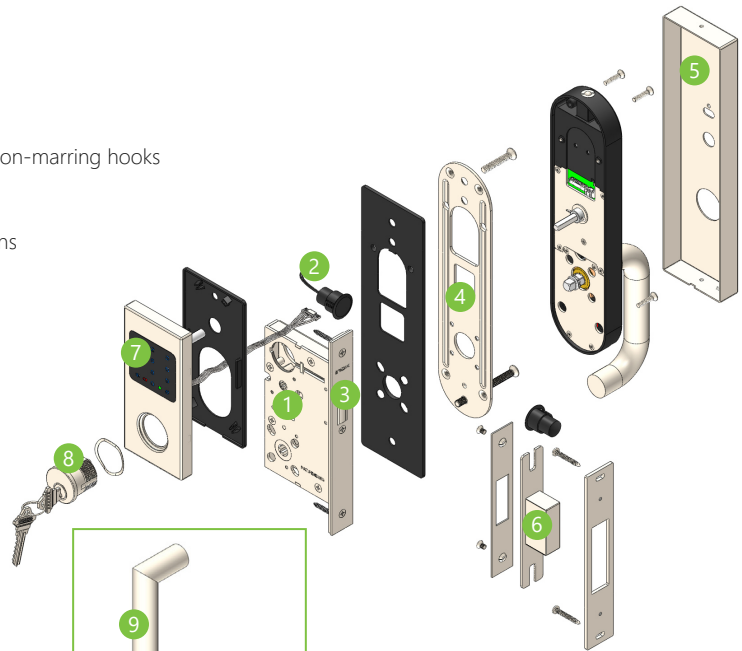

COMPONENTS

- 1 PD95 lockcase and faceplate 2-3/4" backset or 2-1/2" backset
- 2 Door Position Sensor (DPS)
- 3 1" (25.4mm) heavy-duty brass bolt throw with self-retracting non-marring hooks
- 4 Mounting Sub-plate
- 5 Interior stainless steel plate with choice of X Series lever designs
- 6 3D adjustable Strike with reinforcement plate for door frame
 - Up and down adjustment is $\pm 1/4"$
 - Left and right adjustment is $\pm 1/8"$
 - Front and back adjustment is by adding $\pm 3/64"$ spacers
- 7 Smart Full Plate Keypad with touch-to-lock
- 8 Schlage C keyway, 6 pin 1-1/4" mortise cylinder
- 9 Exterior heavy-duty stainless steel cast plate with choice of X Series lever designs or Surface Pull



HOW TO ORDER

Use the sequence below to create an item code for ordering. Please see price book for parts or additional service upcharges.

PRODUCT	OUTSIDE ROSE	INSIDE PLATE	LEVER	LOCK	BACKSET	BLUETOOTH	KEYPAD	CYLINDER	THUMBTURN	FINISH	HANDING
ISM	-XRA	-SFK	243	-PD9550	A	-BRW	-K1	-S6		-32D	-LH
1	2	3	4	5	6		7	8	9	10	11
	ROSE	PLATE	LEVER				LOCK	BACKSET			
							• Entry	• Backset Blank = 2-3/4" • Backset A = 2-1/2"			
	XRA	SFK	201	202	205	221	243				
			244	276	318	319	320				
			321	328	345	346	509				
							7 KEYPAD				
											
							K1				
											
	PHIX										

*XGT available upon request.

8 CYLINDER AND HOUSING (INCLUDES COLLAR)

- LC = Less Cylinder
- Blank = Standard Mortise 1-1/4" Cylinder
- S6 = Small Format Interchangeable Cylinder (SFIC) Housing 1-1/4", 6-Pin, Less Core, L Clover Cam
- S7 = Small Format Interchangeable Cylinder (SFIC) Housing 1-3/8", 7-Pin, Less Core, L Clover Cam
- L6 = Large Format Interchangeable Cylinder (LFIC) Housing 1-1/2", 6-Pin, Less Core, L Clover Cam
- Order IC Cores and Thick Door Kits (TDKs) separately. (See Price Book)

9 THUMBTURN



11 HANDING

- RH = Right Hand
- LH = Left Hand

8 FINISHES* (STANDARD)

-  32D Satin Stainless Steel
-  32 Bright Stainless Steel
-  19G Graphite Black
-  PVD4 Satin Brass
-  Ceramax Graphite Black (C19G)
-  Ceramax Flat Black (C19)
-  Ceramax Stormy Grey (CGY)
-  Ceramax Dark Bronze (CDB)
-  Ceramax Burnt Bronze (CBB)

*Please see Finish Solutions on INOX website for special order finishes.

LEVER DESIGN OPTIONS



201 COLOGNE
SHOWN AS
19G GRAPHITE BLACK



202 MUNICH
SHOWN AS
32D SATIN STAINLESS STEEL



205 FRANKFURT
SHOWN AS
CERAMAX BURNT BRONZE



221 AURORA
SHOWN AS
CERAMAX STORMY GREY



243 SUNRISE
SHOWN AS
32D SATIN STAINLESS STEEL



244 TWILIGHT
SHOWN AS
CERAMAX DARK BRONZE



276 PLAZA
SHOWN AS
PVD4 SATIN BRASS



318 CAFE
SHOWN AS
CERAMAX FLAT BLACK (C19)



319 HAMPTON
SHOWN AS
CERAMAX GRAPHITE BLACK



320 EMPIRE
SHOWN AS
32 BRIGHT STAINLESS STEEL



321 VALENCIA
SHOWN AS
19G GRAPHITE BLACK



328 JAVA
SHOWN AS
32D SATIN STAINLESS STEEL

SMART SLIDING DOOR LOCK

WITH FULL PLATE KEYPAD

The perfect smart keypad solution across a variety of applications, including commercial, mixed use, multi-tenant offices, and commercial/retail facilities.



CODE COMPLIANCE

- ANSI/BHMA 156.36 Auxiliary Locks
- ABSU A117.1 Accessibility Code
- (ADA Compliant)
- Backend IoT PaaS complies with domestic and international information security standards, privacy, and compliance requirements
- Backend IoT PaaS security covers data and cloud services

FINISHES

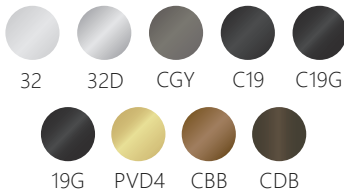

PRODUCT SERIES

ISM-PD95

FEATURES

- Smart Mortise Lock that can be remotely locked, unlocked, and programmed from anywhere in the world
- Motor-driven deadbolt and tamper-resistant design: built-in self-latching and self-locking mechanism secures the door automatically, with ADA-compliant trim
- Offers property owners and managers a platform to create an all-inclusive access management hub with unlimited properties, openings, and users
- Standard exterior and interior gasket included, installation optional
- Compatible Door Position Sensor (DPS) for Metal included (Wood must be ordered separately)

SPECIFICATIONS

Door Thickness	1-3/4" (45mm) Standard
Backset	2-3/4" (70mm)
	2-1/2" (63.5mm)
Center-to-Center Distance	Lever to Cylinder: 3-7/8" (98mm)
	Lever to Thumbturn: 2-11/16" (68mm)
Cylinder	Schlage C keyway 6 pin
	1-1/4" mortise cylinder w/ 2 keys (standard)
	Optional SFIC and LFIC housing and cores available
CAM	CAM01-SCL Clover Cam
Material	Trim: Stainless Steel Lockcase: Heavy Gauge Steel
	Deadbolt: Stainless Steel Cylinder: Solid Brass
	Faceplate/Strike: Stainless Steel

SMART SLIDING DOOR LOCK WITH FULL PLATE KEYPAD

FEATURED CALLOUTS

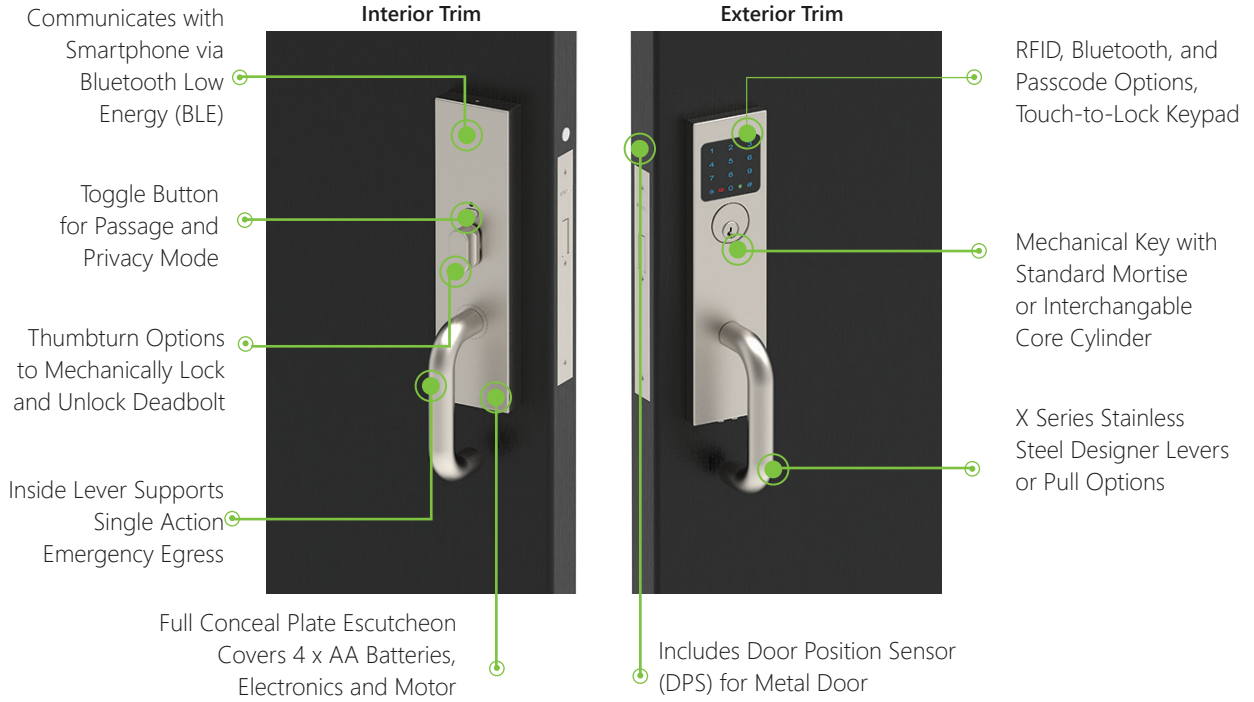

DIMENSIONS

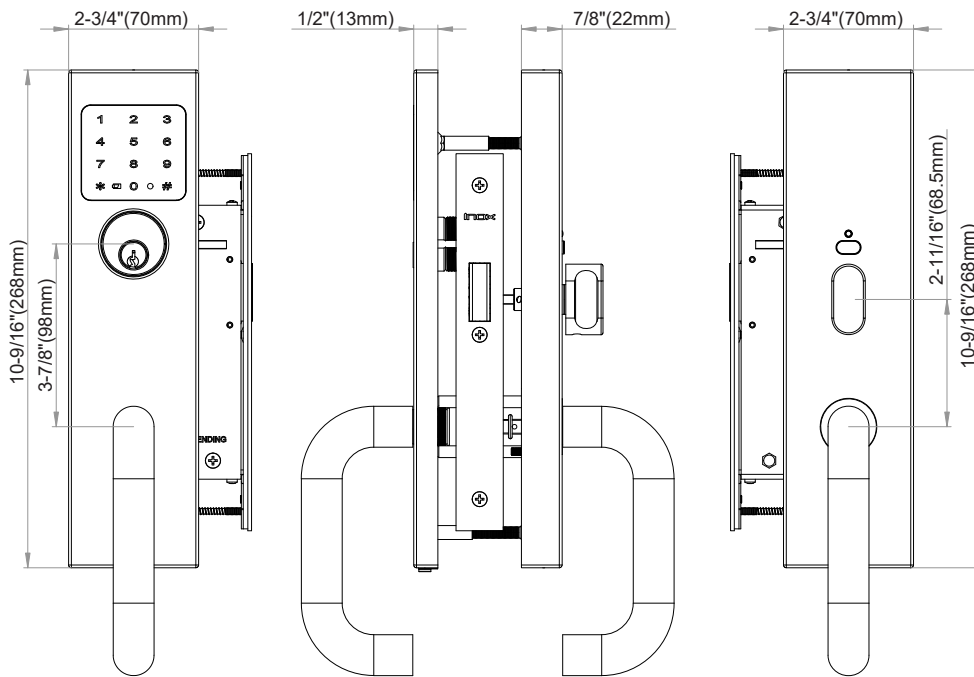

COMPONENTS

- 1 PD95 lockcase and faceplate 2-3/4" backset or 2-1/2" backset
- 2 Door Position Sensor (DPS)
- 3 1" (25.4mm) heavy-duty brass bolt throw with self-retracting non-marring hooks
- 4 Mounting Sub-plate
- 5 Interior stainless steel plate with choice of X Series lever designs
- 6 3D adjustable Strike with reinforcement plate for door frame
 - Up and down adjustment is $\pm 1/4"$
 - Left and right adjustment is $\pm 1/8"$
 - Front and back adjustment is by adding $\pm 3/64"$ spacers
- 7 Smart Full Plate Keypad with touch-to-lock
- 8 Schlage C keyway, 6 pin 1-1/4" mortise cylinder
- 9 Exterior heavy-duty stainless steel cast plate with choice of X Series lever designs

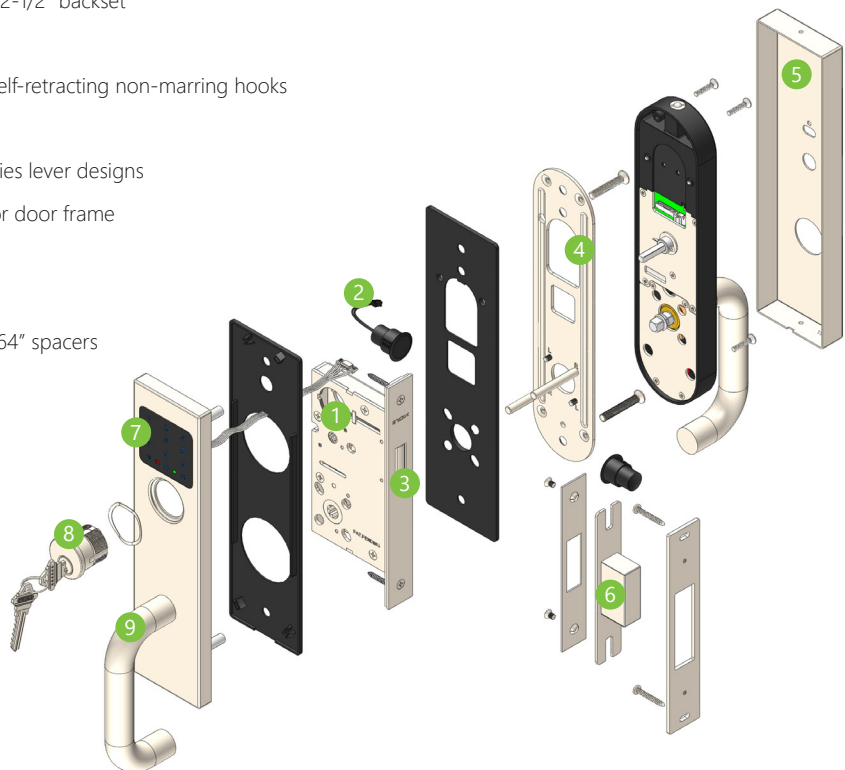

HOW TO ORDER

Use the sequence below to create an item code for ordering. Please see price book for parts or additional service upcharges.

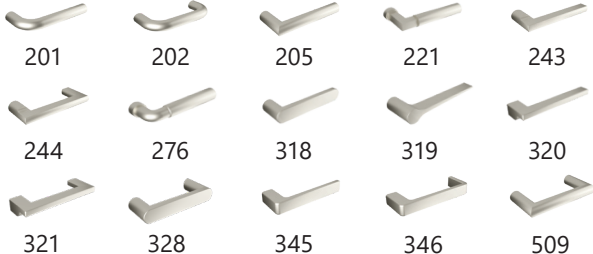
PRODUCT	PLATE	LEVER	LOCK	READER/WRITER	CYLINDER	THUMBTURN	FINISH	HANDING
ISM	-SFK	-243	-PD9550	-BKP		-TT02	-32D	-LH
1	2	3	4		5	6	7	8
PLATE		LEVER			BACKSET			
					<ul style="list-style-type: none"> • PD9550 = 2-3/4" Backset • PD9550A - 2-1/2" Backset 			
SFK								

5 CYLINDER AND HOUSING

- LC = Less Cylinder
- Blank = Standard Mortise 1-1/4" Cylinder
- S6 = SFIC 6-Pin Cylinder Housing
- S7 = SFIC 7-Pin Cylinder Housing

6 THUMBTURN



7 FINISHES* (STANDARD)

-  32D Satin Stainless Steel
-  32 Bright Stainless Steel
-  19G Graphite Black
-  PVD4 Satin Brass
-  Ceramax Graphite Black (C19G)
-  Ceramax Flat Black (C19)
-  Ceramax Stormy Grey (CGY)
-  Ceramax Dark Bronze (CDB)
-  Ceramax Burnt Bronze (CBB)

8 HANDING

- RH = Right Hand
- LH = Left Hand
- RHR = Right Hand Reverse
- LHR = Left Hand Reverse

*Please see Finish Solutions on INOX website for special order finishes.

LEVER DESIGN OPTION



201 COLOGNE
SHOWN AS
19G GRAPHITE BLACK



202 MUNICH
SHOWN AS
32D SATIN STAINLESS STEEL



205 FRANKFURT
SHOWN AS
CERAMAX BURNT BRONZE



221 AURORA
SHOWN AS
CERAMAX STORMY GREY



243 SUNRISE
SHOWN AS
32D SATIN STAINLESS STEEL



244 TWILIGHT
SHOWN AS
CERAMAX DARK BRONZE



276 PLAZA
SHOWN AS
PVD4 SATIN BRASS



318 CAFE
SHOWN AS
CERAMAX FLAT BLACK



319 HAMPTON
SHOWN AS
CERAMAX GRAPHITE BLACK



320 EMPIRE
SHOWN AS
32D SATIN STAINLESS STEEL



321 VALENCIA
SHOWN AS
19G GRAPHITE BLACK



328 JAVA
SHOWN AS
32D SATIN STAINLESS STEEL



345 TOKYO
SHOWN AS
CERAMAX BURNT BRONZE



346 OSAKA
SHOWN AS
CERAMAX STORMY GREY



509 STUTTGARD
SHOWN AS
32D SATIN STAINLESS STEEL

SMART SLIDING DOOR LOCK

SECTIONAL WITH READER

The perfect smart reader solution across a variety of applications, including commercial, mixed use, multi-tenant offices, and commercial/retail facilities.



CODE COMPLIANCE

- ANSI/BHMA 156.36 Auxiliary Locks
- ABSU A117.1 Accessibility Code
- (ADA Compliant)
- Backend IoT PaaS complies with domestic and international information security standards, privacy, and compliance requirements
- Backend IoT PaaS security covers data and cloud services

FEATURES

- Motor-driven deadbolt and tamper-resistant design: Built-in self-latching and self-locking mechanism secures the door automatically, with ADA-compliant trim
- Hygienic and durable: Stainless steel construction with optional CeraMax finishes stands up to hospital-grade cleaning in high-traffic areas
- Auto-locking with emergency egress: Ensures doors lock automatically when closed, while the inside lever always allows safe, single-action egress
- Standard exterior and interior gasket included, installation optional

FINISHES

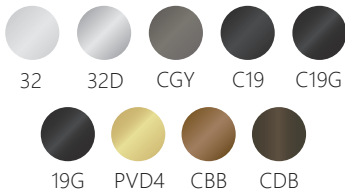

PRODUCT SERIES

ISM-PD95-R1

SPECIFICATIONS

Door Thickness	1-3/4" (45mm) Standard
Backset	2-3/4" (70mm)
	2-1/2" (63.5mm)
Center-to-Center Distance	Lever to Cylinder: 3-7/8" (98mm)
	Lever to Thumbturn: 2-11/16" (68mm)
Cylinder	Schlage C keyway 6 pin
	1-1/4" mortise cylinder w/ 2 keys (standard)
	Optional SFIC and LFIC housing and cores available
CAM	CAM01-SCL Clover Cam
Material	Trim: Stainless Steel Lockcase: Heavy Gauge Steel
	Deadbolt: Stainless Steel Cylinder: Solid Brass
	Faceplate/Strike: Stainless Steel

FEATURED CALLOUTS

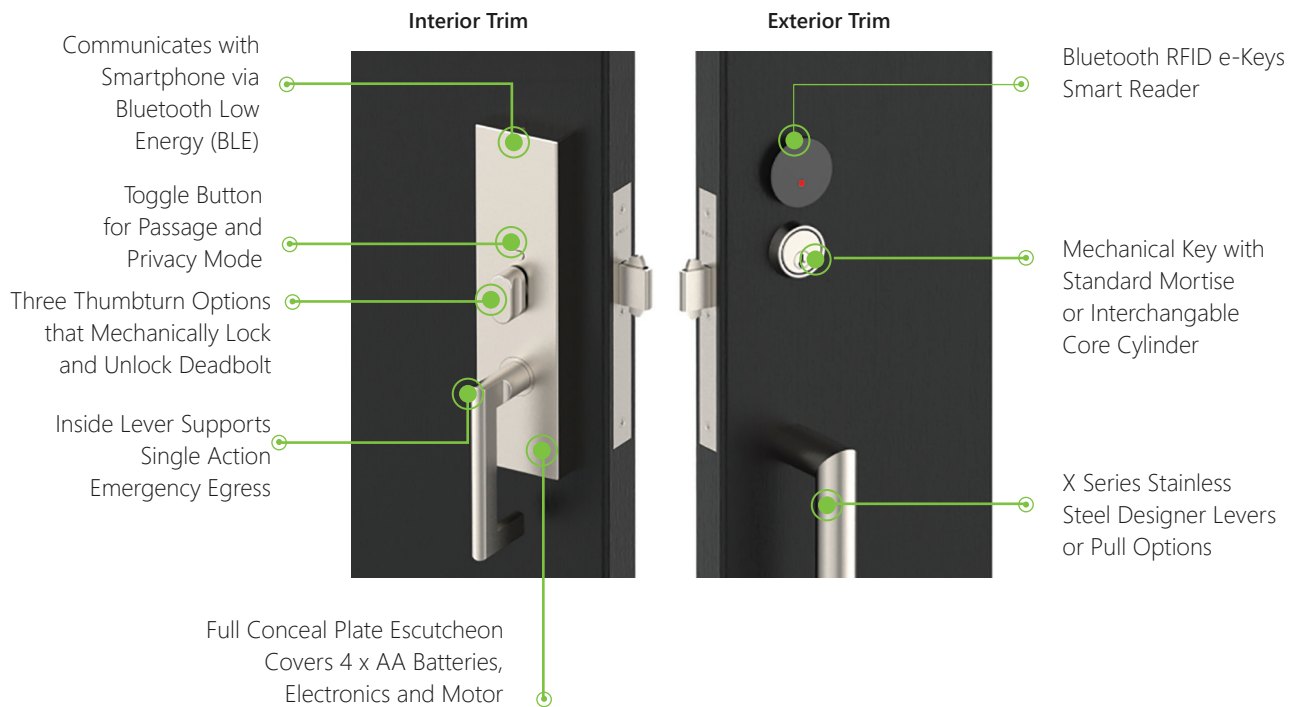

SURFACE PULLS



PHIX31108



PHIX330.512.8



PHIX41714



PHIX45714



PHIX30108

**Exterior Pull Handles are ordered as a separate line item for ISM-PD95 Pull Handle x Lever applications*

DIMENSIONS

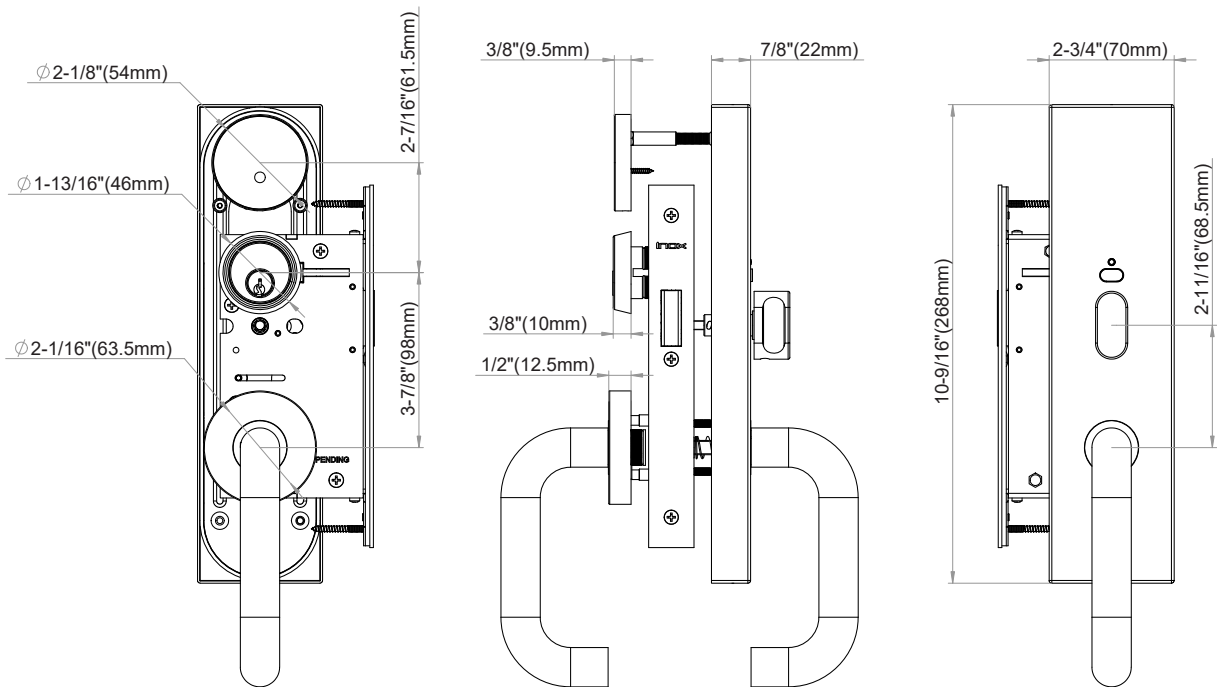

COMPONENTS

- 1 PD95 lockcase and faceplate 2-3/4" backset or 2-1/2" backset
- 2 1" (25.4mm) heavy-duty brass bolt throw with self-retracting non-marring hooks
- 3 Mounting Sub-plate
- 4 3D adjustable Strike with reinforcement plate for door frame
- 5
 - Up and down adjustment is $\pm 1/4"$
 - Left and right adjustment is $\pm 1/8"$
 - Front and back adjustment is by adding $\pm 3/64"$ spacers
- 6 Round R1 Reader
- 7 Schlage C keyway, 6 pin 1-1/4" mortise cylinder
- 8 with choice of X Series lever designs or Exterior Surface Pull

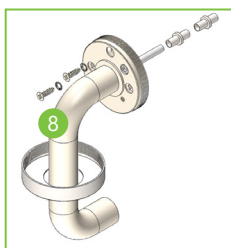
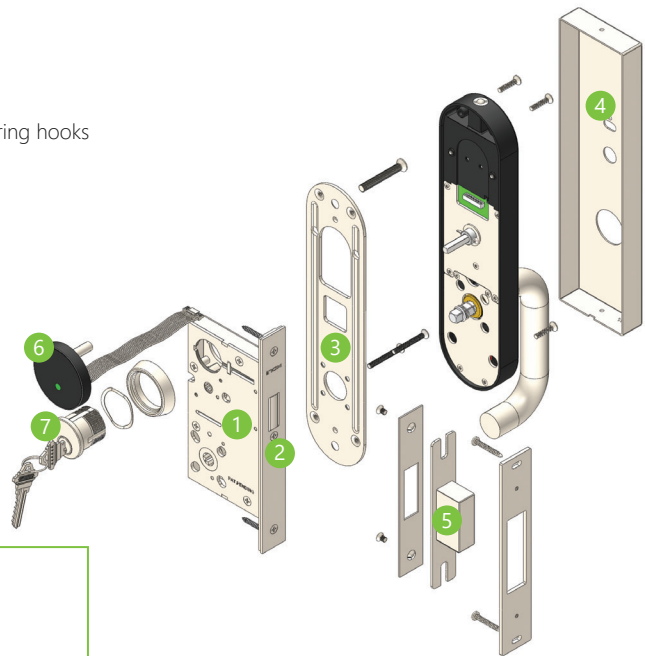

Option 1
X Series Rose w/ Lever

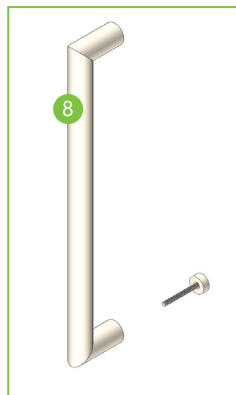





Option 2
Surface Pull

HOW TO ORDER

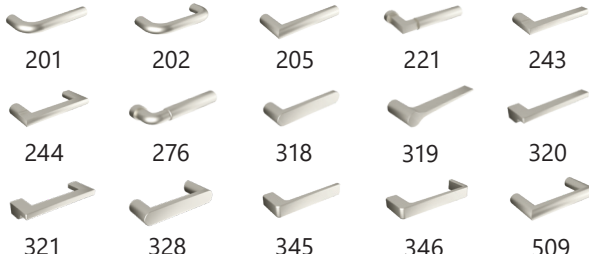
Use the sequence below to order or specify mortise locksets. Please see price book for parts or additional service upcharges.

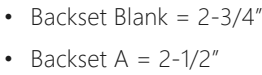
PRODUCT	Outside Trim		Inside Trim			LOCK	BACKSET	READER	CYLINDER	THUMBTURN	FINISH	HANDING
	ROSE	LEVER	PLATE	LEVER	LEVER							
ISM	-XRA	243	-SFK	243		-PD9550	A	-R1	-S6		-32D	-LH
	1	2	3	4	3	5	6	7	8	9	10	11

ROSE	LEVER	PLATE	LOCK	BACKSET
				
XRA	201, 202, 205, 221, 243 244, 276, 318, 319, 320 321, 328, 345, 346, 509	SFK	Entry	Backset Blank = 2-3/4" Backset A = 2-1/2"
			7 READER	
PHIX			R1	

*XGT available upon request.

8 CYLINDER AND HOUSING (INCLUDES COLLAR)

- LC = Less Cylinder
- Blank = Standard Mortise 1-1/4" Cylinder
- S6 = Small Format Interchangeable Cylinder (SFIC) Housing 1-1/4", 6-Pin, Less Core, L Clover Cam
- S7 = Small Format Interchangeable Cylinder (SFIC) Housing 1-3/8", 7-Pin, Less Core, L Clover Cam
- L6 = Large Format Interchangeable Cylinder (LFIC) Housing 1-1/2", 6-Pin, Less Core, L Clover Cam
- Order IC Cores and Thick Door Kits (TDKs) separately. (See Price Book)

9 THUMBTURN



10 FINISHES* (STANDARD)

-  32D Satin Stainless Steel
-  32 Bright Stainless Steel
-  19G Graphite Black
-  PVD4 Satin Brass
-  Ceramax Graphite Black (C19G)
-  Ceramax Flat Black (C19)
-  Ceramax Stormy Grey (CGY)
-  Ceramax Dark Bronze (CDB)
-  Ceramax Burnt Bronze (CBB)

11 HANDING

- RH = Right Hand
- LH = Left Hand

*Please see Finish Solutions on INOX website for special order finishes.

LEVER DESIGN OPTIONS



201 COLOGNE
SHOWN AS
19G GRAPHITE BLACK



202 MUNICH
SHOWN AS
32D SATIN STAINLESS STEEL



205 FRANKFURT
SHOWN AS
CERAMAX BURNT BRONZE



221 AURORA
SHOWN AS
CERAMAX STORMY GREY



243 SUNRISE
SHOWN AS
32D SATIN STAINLESS STEEL



244 TWILIGHT
SHOWN AS
CERAMAX DARK BRONZE



276 PLAZA
SHOWN AS
PVD4 SATIN BRASS



318 CAFE
SHOWN AS
CERAMAX FLAT BLACK



319 HAMPTON
SHOWN AS
CERAMAX GRAPHITE BLACK



320 EMPIRE
SHOWN AS
32D SATIN STAINLESS STEEL



321 VALENCIA
SHOWN AS
19G GRAPHITE BLACK



328 JAVA
SHOWN AS
32D SATIN STAINLESS STEEL

SMART SLIDING DOOR LOCK

FULL PLATE WITH READER

The perfect smart reader solution across a variety of applications, including commercial, mixed use, multi-tenant offices, and commercial/retail facilities.



CODE COMPLIANCE

- ANSI/BHMA 156.36 Auxiliary Locks
- ABSU A117.1 Accessibility Code
- (ADA Compliant)
- Backend IoT PaaS complies with domestic and international information security standards, privacy, and compliance requirements
- Backend IoT PaaS security covers data and cloud services

FINISHES

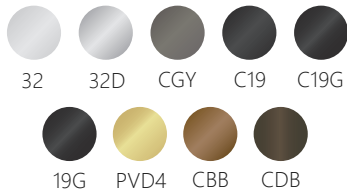

PRODUCT SERIES

ISM-PD95

FEATURES

- Motor-driven deadbolt and tamper-resistant design
- Hygienic and durable: Stainless steel construction with optional CeraMax finishes stands up to hospital-grade cleaning in high-traffic areas
- Auto-locking with emergency egress: Ensures doors lock automatically when closed, while the inside lever always allows safe, single-action egress
- Standard exterior and interior gasket included, installation optional
- Compatible Door Position Sensor (DPS) for Metal included (Wood must be ordered separately)

SPECIFICATIONS

Door Thickness	1-3/4" (45mm) Standard
Backset	2-3/4" (70mm)
	2-1/2" (63.5mm)
Center-to-Center Distance	Lever to Cylinder: 3-7/8" (98mm)
	Lever to Thumbturn: 2-11/16" (68mm)
Cylinder	Schlage C keyway 6 pin
	1-1/4" mortise cylinder w/ 2 keys (standard)
	Optional SFIC and LFIC housing and cores available
CAM	CAM01-SCL Clover Cam
Material	Trim: Stainless Steel Lockcase: Heavy Gauge Steel
	Deadbolt: Stainless Steel Cylinder: Solid Brass
	Faceplate/Strike: Stainless Steel

FEATURED CALLOUTS

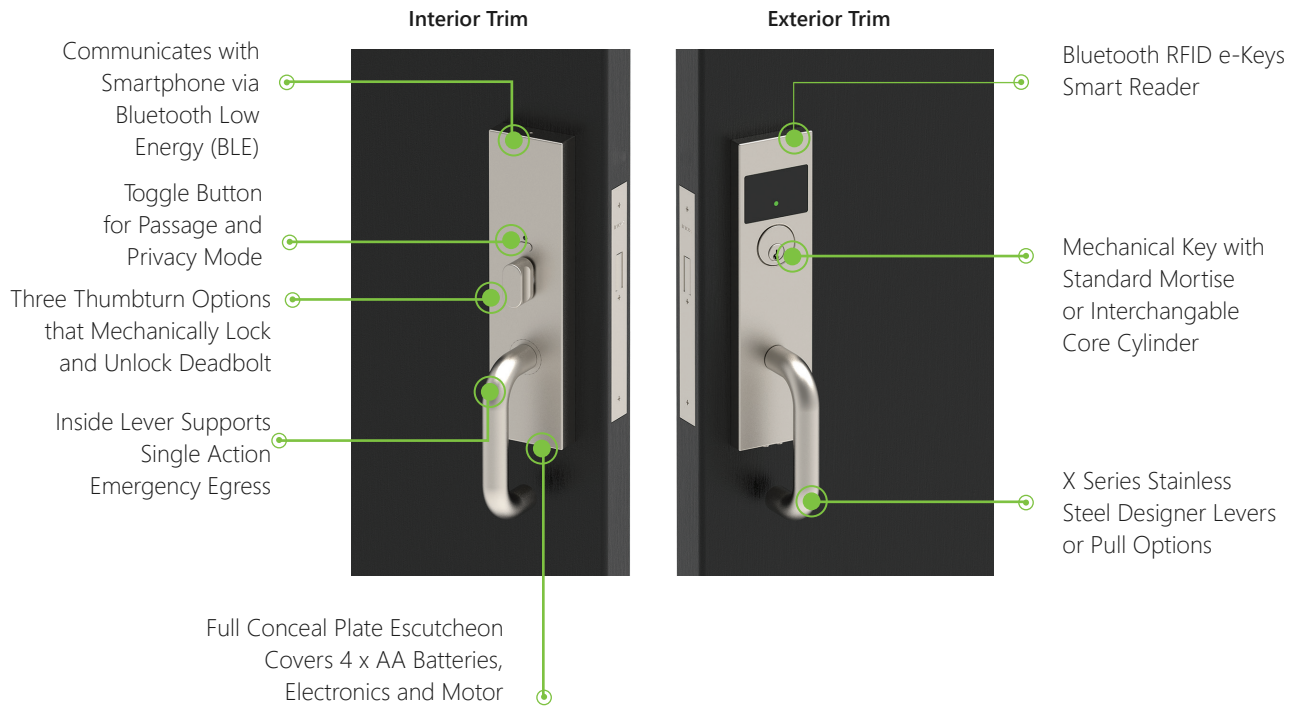

DIMENSIONS

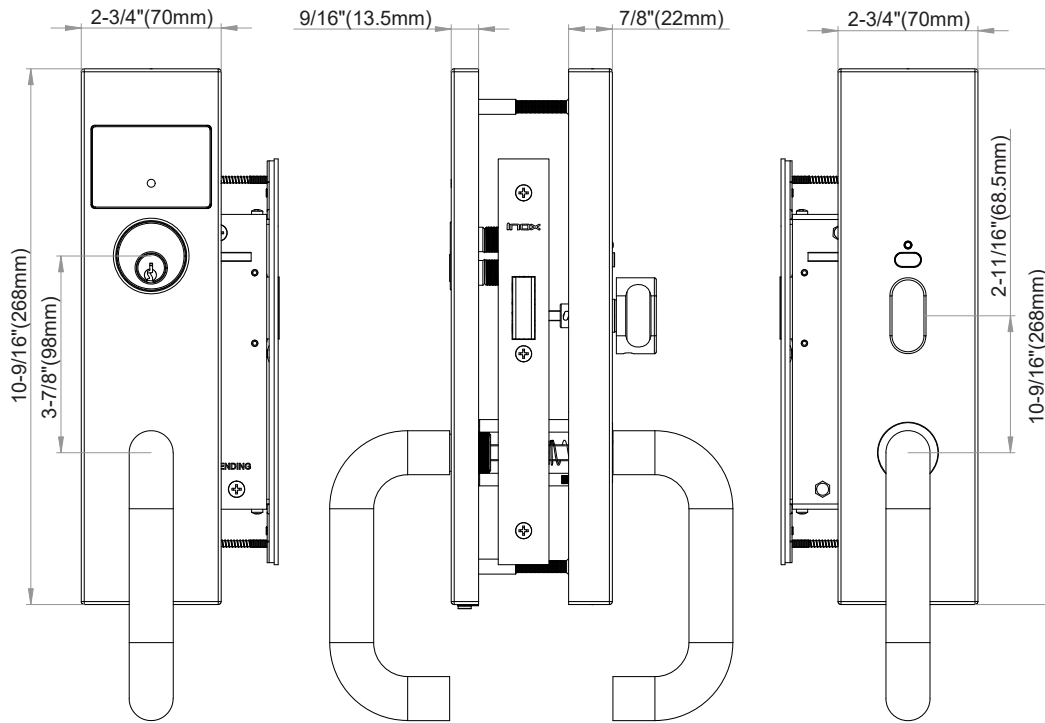





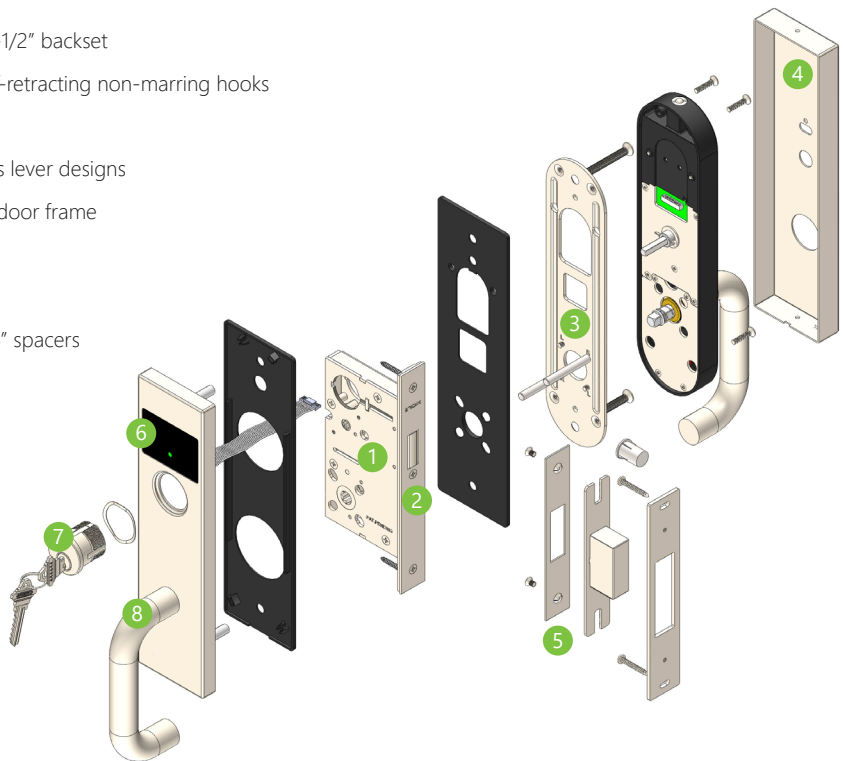











COMPONENTS

- 1 PD95 lockcase and faceplate 2-3/4" backset or 2-1/2" backset
- 2 1" (25.4mm) heavy-duty brass bolt throw with self-retracting non-marring hooks
- 3 Mounting Sub-plate
- 4 Interior stainless steel plate with choice of X Series lever designs
- 5 3D adjustable Strike with reinforcement plate for door frame
- 6
 - Up and down adjustment is $\pm 1/4"$
 - Left and right adjustment is $\pm 1/8"$
 - Front and back adjustment is by adding $\pm 3/64"$ spacers
- Smart Full Plate Reader with touch-to-lock
- 7 Schlage C keyway, 6 pin 1-1/4" mortise cylinder
- 8 Exterior heavy-duty stainless steel cast plate with choice of X Series lever designs



HOW TO ORDER

Use the sequence below to create an item code for ordering. Please see price book for parts or additional service upcharges.

PRODUCT	PLATE	LEVER	LOCK	READER/WRITER	CYLINDER	THUMBTURN	FINISH	HANDING
ISM	-SFR	-243	-PD9550	-BRW		-TT02	-32D	-LH
1	2	3	4		5	6	7	8
PLATE	LEVER					BACKSET		
						<ul style="list-style-type: none"> • PD9550 = 2-3/4" Backset • PD9550A = 2-1/2" Backset 		
	201	202	205	221	243			
								
	244	276	318	319	320			
								
	321	328	345	346	509			

5 CYLINDER AND HOUSING (INCLUDES COLLAR)

- LC = Less Cylinder
- Blank = Standard Mortise 1-1/4" Cylinder
- S6 = SFIC 6-Pin Cylinder Housing
- S7 = SFIC 7-Pin Cylinder Housing

6 THUMBTURN



7 FINISHES* (STANDARD)

-  32D Satin Stainless Steel
-  32 Bright Stainless Steel
-  19G Graphite Black
-  PVD4 Satin Brass
-  Ceramax Graphite Black (C19G)
-  Ceramax Flat Black (C19)
-  Ceramax Stormy Grey (CGY)
-  Ceramax Dark Bronze (CDB)
-  Ceramax Burnt Bronze (CBB)

8 HANDING

- RH = Right Hand
- LH = Left Hand
- RHR = Right Hand Reverse
- LHR = Left Hand Reverse

*Please see Finish Solutions on INOX website for special order finishes.

LEVER DESIGN OPTIONS



201 COLOGNE
SHOWN AS
19G GRAPHITE BLACK



202 MUNICH
SHOWN AS
32D SATIN STAINLESS STEEL

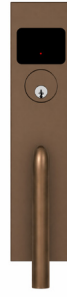

205 FRANKFURT
SHOWN AS
CERAMAX BURNT BRONZE



221 AURORA
SHOWN AS
CERAMAX STORMY GREY



243 SUNRISE
SHOWN AS
32D SATIN STAINLESS STEEL



244 TWILIGHT
SHOWN AS
CERAMAX DARK BRONZE



276 PLAZA
SHOWN AS
PVD4 SATIN BRASS



318 CAFE
SHOWN AS
CERAMAX FLAT BLACK



319 HAMPTON
SHOWN AS
CERAMAX GRAPHITE BLACK



320 EMPIRE
SHOWN AS
32D SATIN STAINLESS STEEL



321 VALENCIA
SHOWN AS
19G GRAPHITE BLACK



328 JAVA
SHOWN AS
32D SATIN STAINLESS STEEL



345 TOKYO
SHOWN AS
CERAMAX BURNT BRONZE



346 OSAKA
SHOWN AS
CERAMAX STORMY GREY



509 STUTTGARD
SHOWN AS
32D SATIN STAINLESS STEEL



1 2 3
4 5 6
7 8 9
* 0 #





PERSPECTIVES
CONTEMPORARY WORKS

Smart Multipoint Trim

SMART MULTIPOINT TRIM

MORTISE

A commercial grade lock with built-in RF reader and digital keypad, offering Smart Access Technology for commercial and residential entry doors for offices, multifamily and mixed use properties.



FINISHES

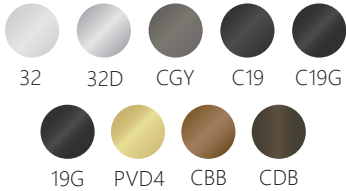

PRODUCT SERIES

ISMP

FEATURES

- Converts conventional Euro Multipoint Lock into an INOX Smart Locking system
- Compatible with most multipoint lock trim brands for remote locking and unlocking
- Patent Pending Electro-Mechanical Locking Mechanism for touchless auto-locking
- Manual lift-to-lock action triggers the cylinder to auto-lock and deadlock both interior and exterior levers
- Interior thumbturn unlocks the lever for easy egress
- Standard exterior and interior gasket included, installation optional

SPECIFICATIONS

Door Thickness	1-3/4" - 2-1/4" Standard (Thick Door Kits Available)
Backset	Minimum 30mm
CTC	92mm standard 85mm Special Order
Handing	Specify handing when ordering
Cylinder	INOX 6-Pin Schlage C Keyway Knob Cylinder with Tailpiece
Material	Trim: Stainless Steel

- Backend IoT PaaS complies with domestic and international information security standards, privacy and compliance requirements
- Backend IoT PaaS security covers data and cloud services



FEATURED CALLOUTS

LEVER LOW TRIM

Interior Trim

- Full Conceal Plate Escutcheon Covers 4 x AA Batteries, Electronics and Motor
- Optional Toggle Button for Passage and Privacy Mode
- Three Thumbturn Options that Mechanically Lock and Unlock Deadbolt
- Communicates with Smartphone via Bluetooth Low Energy

Exterior Trim

- RFID, Bluetooth, and Passcode Options, Touch-to-Lock Keypad
- Mechanical Key Override with INOX Knob Cylinder
- 15 Standard Stainless Steel Designer Levers with Various Finish Options
- USB Type C Emergency Power Outlet

ISMP/VL

LEVER HIGH TRIM

Interior Trim

- Full Conceal Plate Escutcheon Covers 4 x AA Batteries, Electronics and Motor
- Communicates with Smartphone via Bluetooth Low Energy
- Three Thumbturn Options that Mechanically Lock and Unlock Deadbolt
- Optional Toggle Button for Passage and Privacy Mode

Exterior Trim

- RFID, Bluetooth, and Passcode Options, Touch-to-Lock Keypad
- 15 Standard Stainless Steel Designer Levers with Various Finish Options
- Mechanical Key Override with INOX Knob Cylinder
- USB Type C Emergency Power Outlet

ISMP/VH

SMART MULTIPOINT TRIM (MORTISE)

DIMENSIONS

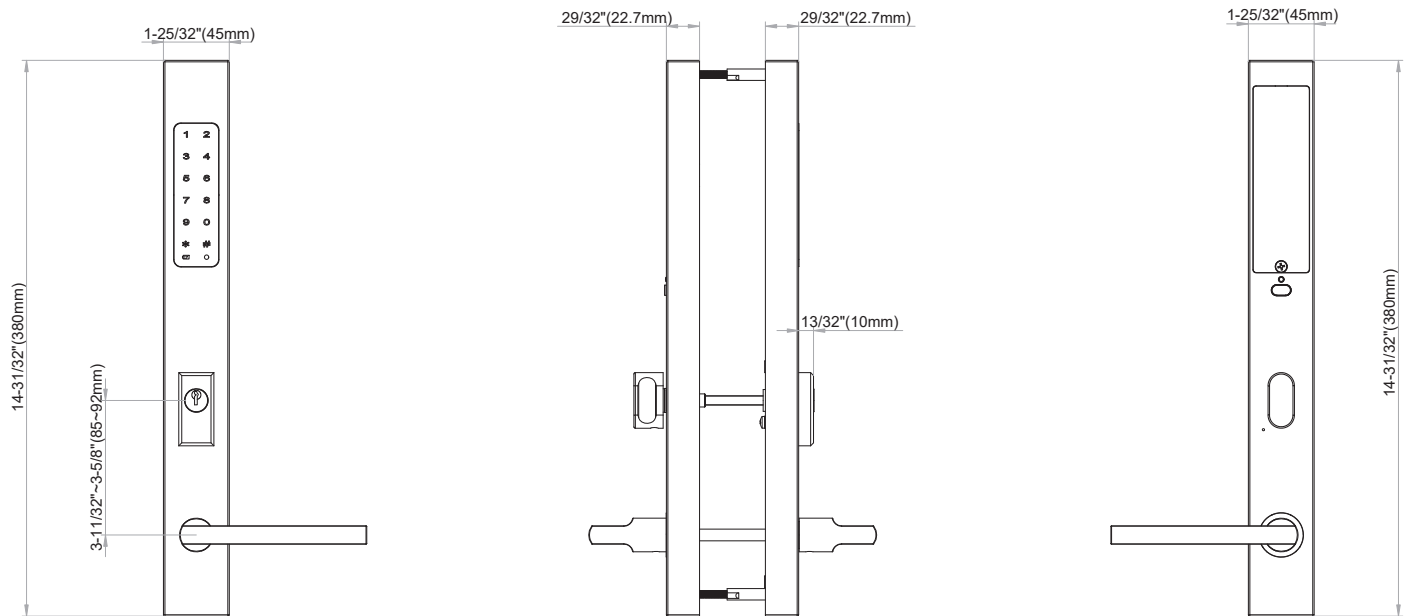

COMPONENTS

- 1 Exterior concealed stainless steel escutcheon plate with choice INOX lever designs
- 2 Multi Credential Digital Keypad
- 3 INOX Knob Cylinder
- 4 Interior Sub-Plate
- 5 Interior concealed stainless steel escutcheon plate with batteries container
- 6 INOX Euro Cylinder Adapter
- 7 Compatible Euro Multipoint Lock*

**Not supplied by INOX. If you have any questions regarding compatibility between 3rd party Multipoint Lock and INOX ISMP Trim, please contact technical support.*



DIMENSIONS

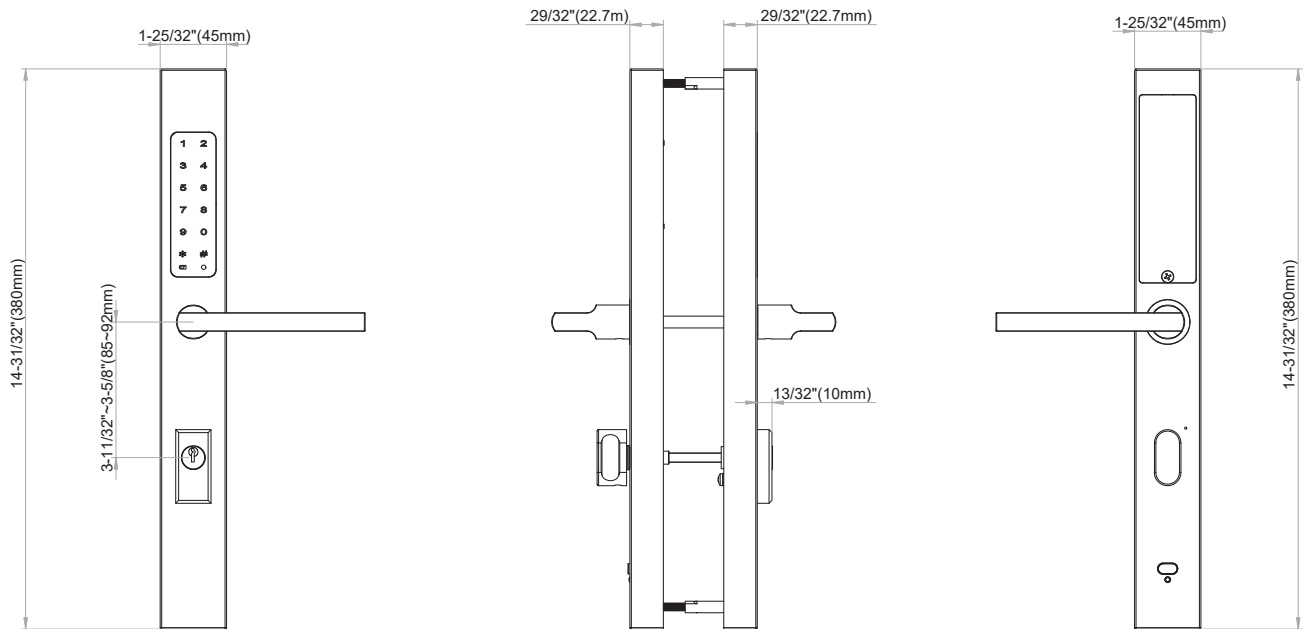

COMPONENTS

- 1 Exterior concealed stainless steel escutcheon plate with choice INOX lever designs
- 2 Multi Credential Digital Keypad
- 3 INOX Knob Cylinder
- 4 Interior sub-plate
- 5 Interior concealed stainless steel escutcheon plate with batteries container
- 6 INOX Euro Cylinder Adapter
- 7 Compatible Euro Multipoint Lock*

















**Not supplied by INOX. If you have any questions regarding compatibility between 3rd party Multipoint Lock and INOX ISMP Trim, please contact technical support.*



SMART MULTIPOINT TRIM (MORTISE)

HOW TO ORDER

Use the sequence below to create an item code for ordering. Please see price book for parts or additional service upcharges.

PRODUCT	PLATE	LEVER	FUNCTION/ CYLINDER	LEVER POSITION	CENTER-TO- CENTER (CTC)	THUMBTURN	FINISH	HANDING	
ISMP	-MUK	-243	-MA55	-VL			-32D	-LH	
1	2	3	4	5	6	7	8	9	
LEVER			FUNCTION/ CYLINDER		LEVER POSITION	CENTER-TO- CENTER (CTC)			
					<ul style="list-style-type: none"> • MA55 • DMP 	  -VL -VH	<ul style="list-style-type: none"> • Blank = 92mm (Standard) • 85 = 85mm (Special Order) 		
201	202	205	221	243					
									
244	276	318	319	320					
									
321	328	345	346	509					

7 THUMBTURN



8 FINISHES* (STANDARD)



*Please see Finish Solutions on INOX website for special order finishes.

9 HANDING

- RH = Right Hand
- LH = Left Hand

LEVER DESIGN OPTIONS



319 HAMPTON
SHOWN AS
CERAMAX GRAPHITE BLACK



320 EMPIRE
SHOWN AS
32 BRIGHT STAINLESS STEEL



321 VALENCIA
SHOWN AS
19G GRAPHITE BLACK



328 JAVA
SHOWN AS
32D SATIN STAINLESS STEEL



345 TOKYO
SHOWN AS
CERAMAX BURNT BRONZE



346 OSAKA
SHOWN AS
CERAMAX STORMY GREY



509 STUTTGARD
SHOWN AS
32 BRIGHT STAINLESS STEEL



243 SUNRISE
SHOWN AS
PVD4 SATIN BRASS

**All Exterior Trim Configurations above are shown in Right Hand (RH) Door Configuration*

LEVER DESIGN OPTIONS



201 COLOGNE
SHOWN AS
CERAMAX GRAPHITE BLACK



202 MUNICH
SHOWN AS
32D SATIN STAINLESS STEEL



205 FRANKFURT
SHOWN AS
CERAMAX BURNT BRONZE



221 AURORA
SHOWN AS
CERAMAX STORMY GREY



244 TWILIGHT
SHOWN AS
CERAMAX DARK BRONZE



276 PLAZA
SHOWN AS
PVD4 SATIN BRASS



318 CAFE
SHOWN AS
CERAMAX FLAT BLACK

**All Exterior Trim Configurations above are shown in Right Hand (RH) Door Configuration*

Smart Exit Device Trim

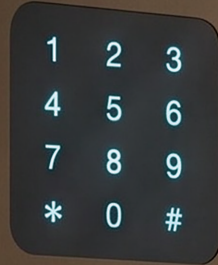

SMART EXIT DEVICE TRIM

KEYPAD

Enhances security and convenience by allowing authorized entry while preserving the exit device's emergency egress function. Designed for commercial, multifamily, and mixed-use properties.



CODE COMPLIANCE

- ANSI/BHMA A156.3 Grade 1 Exit Devices
- ANSI/BHMA A156.29 Exit Lock & Alarm
- UL Listed for ANSI/UL10B and UL10C,
- CAN/ULC S104 up to 3 Hours
- UBC Standard 7-2 (1997) NFPA 252
- ANSI/UL 305 and CAN/ULC-S132
- NFPA 80 National Fire Protection (Fire Door Assembly)
- NFPA101 National Fire Protection (Life Safety)
- ANSI/BHMA A156.18 Finishes
- ANSI A117.1 ADA Accessibility
- Electrification: ANSI/UL634, ANSI/UL294, ANSI/UL10C

FINISHES

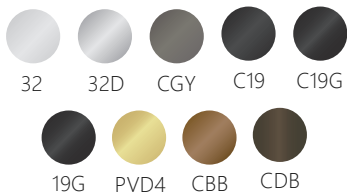

PRODUCT SERIES

ISED

FEATURES

- INOX Smart Trim available in RIM, SVR/CVR and Mortise to compatible Sargent models
- Standard exterior and interior gasket included, installation optional
- Compatible Door Position Sensor (DPS) for Metal included (Wood must be ordered separately)

RIM EXIT DEVICE SPECIFICATIONS

Device Functions	For use with Standard Exit Devices, trim available separately
Device Lengths	3': 2'2" to 3' (660mm to 914mm) 4': 2'9" to 4' (838mm to 1219mm)
Strikes	Dull Black Rim Strike (EDLSR-239)
Dogging Feature	Hex Key Dogging available on Non-Fire Rated devices only
Dogging Options	Cylinder Dogging kits available
Electric Options	Alarm Kit 36" and 48" available
Miscellaneous	GBK: Glass Bead Kit
Fasteners & Sex Bolts	Furnished with wood & machine screws; thru-bolt standard on Fire-Rated devices
Latch Bolt	Stainless Steel 3/4" (19mm) throw
Device Centerline from Finished Floor	41" (1041mm)
Center Case Dimensions	8-3/32" x 2-13/16" x 2-15/32" (206mm x 71mm x 63mm)
Mechanism Case Dimensions	2-3/16" x 1-15/6" (55.4mm x 49.1mm)
Pushbar Projections	Neutral: 3-3/4" (95.3mm) / Depressed: 2-15/16" (74.5mm)

SMART EXIT DEVICE TRIM (KEYPAD)

FEATURED CALLOUTS



COMPONENTS

- 1 RFID, Bluetooth, Passcode with Touch-to-Lock Keypad
- 2 Exterior heavy duty stainless steel cast plate with choice of X Series lever designs
- 3 Schlage C keyway, 6 pin 1-1/4" mortise cylinder w/Collar
- 4 Weather Gasket (Outside)
- 5 SVF Bracket *
- 6 Weather Gasket (Inside)
- 7 Interior Sub-Plate
- 8 Interior housing plate with PCB board
- 9 Stainless Steel Interior Faceplate Cover



* Only included with ISED-SUK

DIMENSIONS

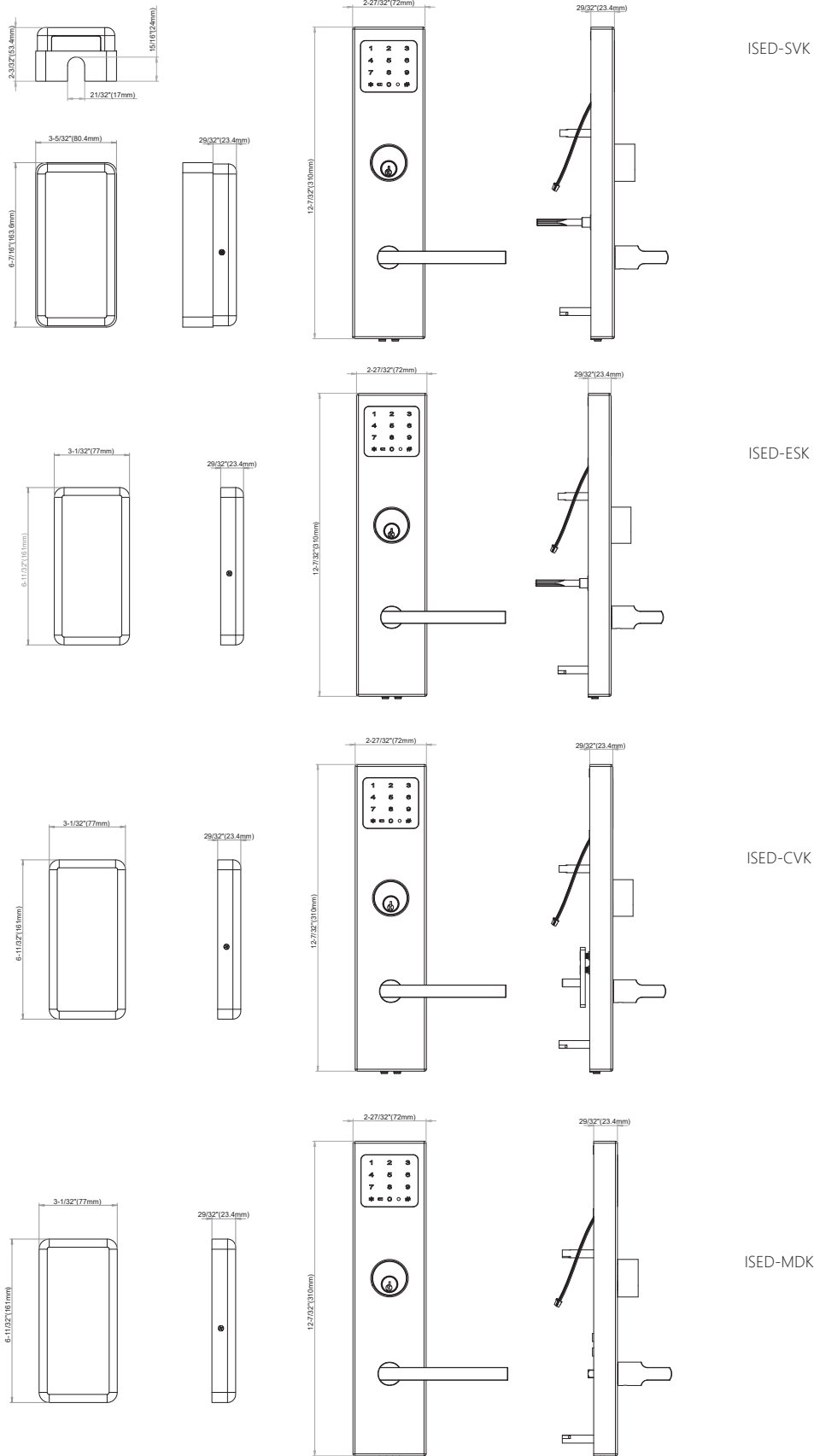



















HOW TO ORDER

RETROFIT COMPATIBILITY CHART

ED93	ALLEGION FALCON	SARGENT	VON DUPRIN	GENERAL LOCK
RIM	Compatible After Modifications	Compatible After Modifications	Not Compatible	Fully Compatible
MED	Not Compatible	Compatible After Modifications	Fully Compatible	Not Compatible
CVR	Compatible After Modifications	Not Compatible	Fully Compatible	Not Compatible
SVR	Not Compatible	Not Compatible	Not Compatible	Not Compatible

Use the sequence below to create an item code for ordering. Please see price book for parts or additional service upcharges.

PRODUCT	TRIM	LEVER	ENTRY FUNCTION	FINISH	HANDING
ISED- 1	ESK 2	243- 3	EN- 4	32D- 5	LH 6
					
PRODUCT	TRIM	LEVER			
	ESK RIM Exit Device CVK CVR Exit Device MDK MD Exit Device SVK SVR Exit Device	 201  202  205  221  243  244  276  318  319  320  321  328  345  346  509			

5 FINISHES* (STANDARD)

-  32D Satin Stainless Steel
-  Ceramax Graphite Black (C19G)
-  32 Bright Stainless Steel
-  Ceramax Flat Black (C19)
-  19G Graphite Black
-  Ceramax Stormy Grey (CGY)
-  PVD4 Satin Brass
-  Ceramax Dark Bronze (CDB)
-  Ceramax Burnt Bronze (CBB)

*Please see Finish Solutions on INOX website for special order finishes.

6 HANDING

- RHR – Right Hand Reverse
- LHR – Left Hand Reverse

LEVER DESIGN OPTIONS



201 COLOGNE
SHOWN AS
19G GRAPHITE BLACK



202 MUNICH
SHOWN AS
32D SATIN STAINLESS STEEL



205 FRANKFURT
SHOWN AS
CERAMAX BURNT BRONZE



221 AURORA
SHOWN AS
CERAMAX STORMY GREY



243 SUNRISE
SHOWN AS
32D SATIN STAINLESS STEEL



244 TWILIGHT
SHOWN AS
CERAMAX DARK BRONZE



276 PLAZA
SHOWN AS
32D SATIN STAINLESS STEEL



318 CAFE
SHOWN AS
CERAMAX FLAT BLACK



319 HAMPTON
SHOWN AS
CERAMAX GRAPHITE BLACK



320 EMPIRE
SHOWN AS
32D SATIN STAINLESS STEEL



321 VALENCIA
SHOWN AS
19G GRAPHITE BLACK



345 TOKYO
SHOWN AS
CERAMAX BURNT BRONZE



346 OSAKA
SHOWN AS
CERAMAX STORMY GREY



509 STUTTGARD
SHOWN AS
32D SATIN STAINLESS STEEL

**All Exterior Trim Configurations above are shown in Right Hand (RH) Door Configuration*

Smart Glass Door Locks



SMART GLASS DOOR LOCK

WITH KEYPAD

Enhances security and convenience by enabling authorized access while maintaining glass door integrity with no cutting required. Designed for offices, multifamily, and light commercial spaces.



CODE COMPLIANCE

- No Hole Drilling or Door Prep Required
- Proprietary Winged Deadbolt Design
- Semiconductor Fingerprint Sensors Touch-to-Lock Keypad
- Biometric Security to keep Fingerprint and Face ID Data private
- ADA Compliant Design
- Emergency External Power Interface
- Low Voltage Detection Alarm
- iOS and Android available
- Add / Delete users by APP
- Double Verification Mode
- Temporary Password (One-time or Period Code)
- Remote Access (Supports 3G/4G/5G)
- Self-Contained Doorbell Operation
- Part of the INOX Smart Ecosystem that supports unlimited properties, doors and devices

PRODUCT SERIES

ISGK-B750

FEATURES

- Combining cutting-edge technology with user-friendly features, the ISGK-B750 offers enhanced protection and seamless accessibility for both residential and commercial spaces
- Available for frameless sliding glass doors, swing glass door, as well as wooden frame applications with Bluetooth Gateway pairing capabilities

SPECIFICATIONS

Material	SUS304 stainless steel, aluminum alloy, tempered glass
Standard	190mm x 117mm x 61.6mm
Support Functions	English and Spanish support, LCD display, 3 volume levels, sound & light notify of incorrect password, door opening record inquiry, ect
Optional Opening	Mobile phone Bluetooth APP unlocking and remote WIFI unlocking (requires a Bluetooth gateway)
Face Recognition	Binocular 3D face recognition at 12" to 23" distance
Fingerprint Imaging	Semiconductor fingerprint sensors
Fingerprint ID Rate	Identification speed 0.4S Identification error ≤ 0.0001%
Current	Static current ≤ 150 μ A, dynamic current <380mA
Working Power	One 7.4V Lithium Battery with charger included
User	Face: 100 Fingerprint: 50 Card: 50 Password: 50
Card Type	IC card (13.56MHZ M1 card)
Working Temp.	-13°F to 149°F (-25°C to 65°C) Indoors
Suitable Door Type	Standard: 1/2" to 3/4" (12.7mm to 19mm) Thin Door Kit: 1/4" to 3/8" (6.35mm to 9.5mm)

DIMENSIONS

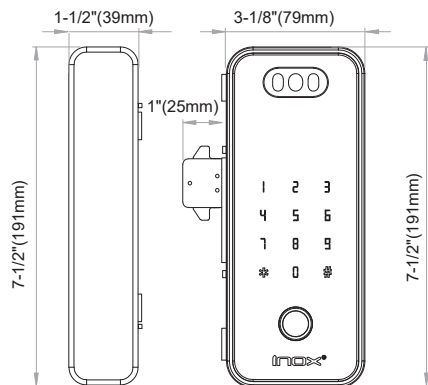

Standard Door Size (with shims)
 1/2" to 3/4" (12.7mm to 19mm)
 *Thin Door Kit available for 1/4" to 3/8"
 (6.35mm to 9.5mm) door thickness

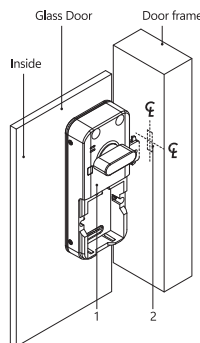

For Right Handed Glass Door

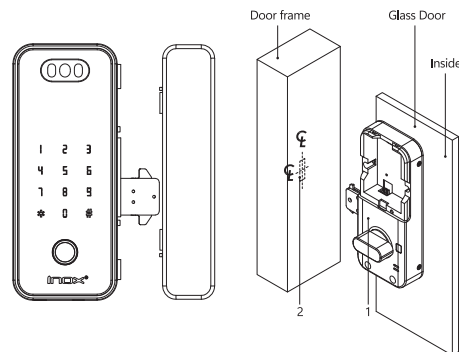

For Left Handed Glass Door

APP CAPABILITIES

- Multiple Unlock Methods: The Smart Glass Door Lock supports various access methods, including Face and Fingerprint ID, passcodes, RFID, mobile credentials, and electrified key override.
- Remote Access and Control: Users can lock and unlock the door remotely through a smartphone app, which is particularly useful for granting temporary access to guests or service providers.
- Automatic Locking: The lock can be set to auto-lock after a specified period, ensuring the door remains secure even if the user forgets to lock it manually.
- User Management: It allows multiple users to be added with different access levels. This feature is ideal for managing access in shared spaces such as offices or commercial buildings.
- Audit Trail and Logs: The lock can record user activity and unlock history, providing a detailed log of who accessed the door and when. This is useful for security monitoring and auditing.



Download the INOX Smart App today!





COFFEE
PASTRIES
SANDWICHES
& MORE



Multi- Credential Reader Controller



MULTI-CREDENTIAL READER

CONTROLLER

Designed for high volume openings and connecting to any hardwired electrified door hardware, making it the perfect solution across commercial, mixed-use, hospitality, and residential applications.



TECHNOLOGY



Wi-Fi



Bluetooth



RFID Card



Mobile Access



Cloud-Based



Wiegand

FINISHES



AL



BK

PRODUCT SERIES

ISK-B300

FEATURES

- Mobile-enabled multi-credential EAC device with all-in-one reader, controller, and monitor
- Supports secure 13.56MHz RFID such as FOB, Cards or Wristband
- Advanced roles and permission customization for real-time user access management
- Cloud-based monitoring, user roles and permission management functions
- Integration with multiple buildings in multiple physical locations
- Easy to install and integrate with all types of electrified locking devices
- Reduced installation and maintenance costs
- Compatible Door Position Sensor (DPS) for Metal included (Wood must be ordered separately)

SPECIFICATIONS

Keypad	Backlit Digital Touchscreen
Style	Mullion
Frequency	125KHz / 13.56MHz
Input Voltage	12/24 V DC
RF Output	13.56MHz or 125kHz (reader) 26-Bit Wiegand
Read Interface	EM / Mifare
Read Range	~3/4" to 2-1/2"
Working Current	<80mA (12V) ~ <40mA (24V)
Idle Current	<30mA (12V) ~ <20mA (24V)
User Capacity	2000 Total (1000 RFID/Passcode + 1000 Mobile)
Working Humidity	0% to 98%
Working Temp.	-20°F to 140°F
Dimensions	5-7/8" x 1-3/4" x 7/8" (150mm x 44mm x 22mm)
Material	Die Cast Metal

FEATURES & FUNCTIONS



BLUETOOTH READER WITH DIGITAL KEYPAD

- Communicates with Wi-Fi smartphone, Wi-Fi gateway or POE gateway through Bluetooth Low Energy technology space
- Supports 1000 mobile credentials per device and 1000 RFID or App programmable passcodes
- Authorized users can create, edit, or remove three types of passcodes - system-generated, user-defined, or one-time passcodes - from the intuitive INOX Smart App



ONLINE AND OFFLINE RFID READER

- Supports secure 13.56MHz RFID such as FOB, Cards or Wristband
- Authorized users can add, edit or remove RFID credentials through the INOX Smart App
- Operates offline by storing authorized credentials locally, making it a more robust solution for environments with intermittent network connectivity

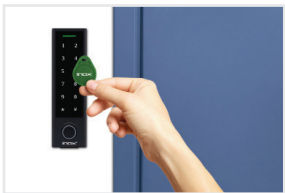

RFID REGISTRATION AND ENROLLMENT DEVICE

- The ISK-B300 is an RFID registration/enrollment device
- Registers new RFID cards or FOB without requiring additional encoder equipment
- Associates the RFIDs with permissions and customized schedules in a Cloud database
- Authorized users can remove or edit RFID information on the cloud and devices using INOX Smart App



ONLINE AND OFFLINE RFID READER

- The ISK-B300 comes equipped with a built-in SPDT relay that has a programmable hold delay
- It seamlessly integrates with various access control hardware such as electrified mortise locks, cylindrical locks, electrified exit device trim, electric strikes, and maglocks
- The relay hold time is adjustable via the App, ranging from 5 seconds to 5 minutes, which supports ADA accessibility



DIMENSIONS

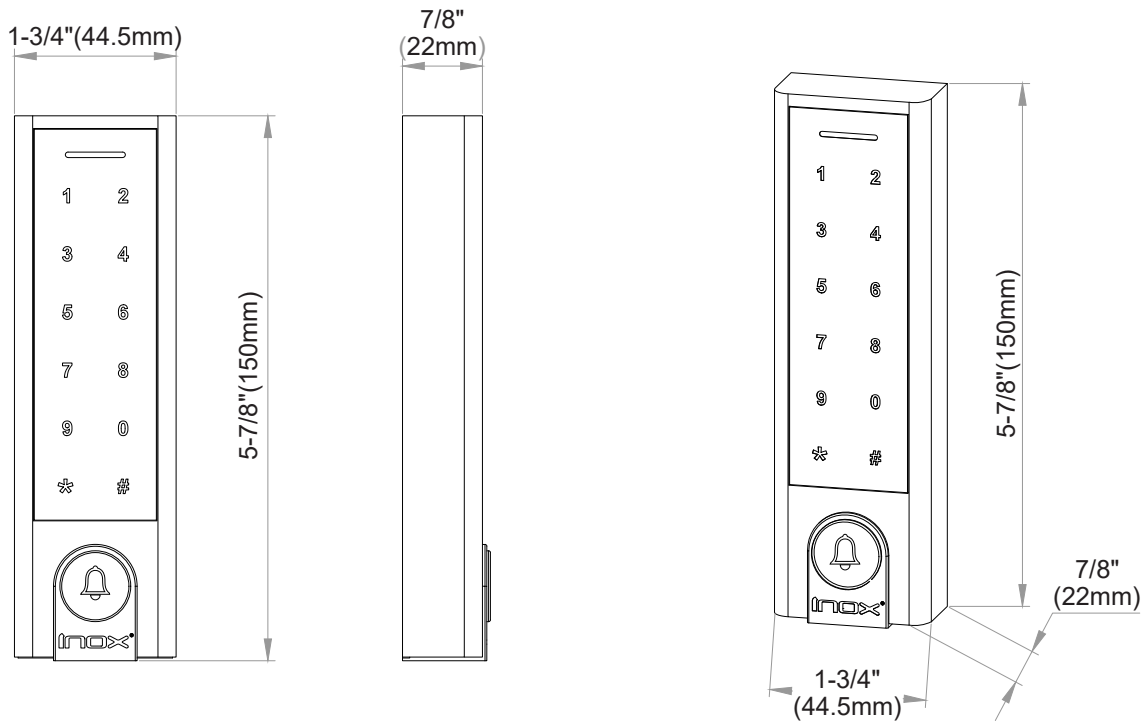

WIRING DIAGRAM

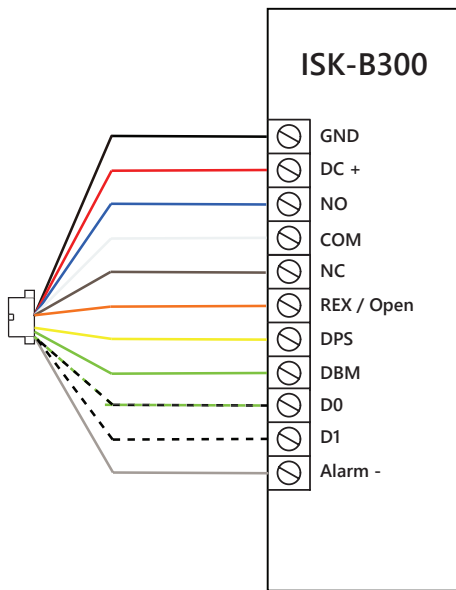

WIRE COLOR	FUNCTION	NOTES
Basic Standalone Wiring		
Black	GND	Negative Pole of DC Power Input
Red	DC+	12-24V DC Power Input
Blue	Relay NO	Normally Open Relay (w/ diode)
White	Relay Common	Common Connection Relay Output
Brown	Relay NC	Normally Closed Relay (w/ diode)
Orange	REX/Open	Request to Exit (REX) Input
Pass-through Wiring (Wiegand Reader or Controller)		
Green / Black	Data 0	Wiegand Output (Pass-Through) Data 0
White / Black	Data 1	Wiegand Output (Pass-Through) Data 1
Advanced Input & Output		
Yellow	DPS Input	Negative contact for Alarm
Green	DBM Input	Door Contact Input (Normally Closed)
Grey	Alarm Output	Deadbolt Open Detection Input

ACCESS CONTROL

IN A BOX

The INOX ACBX (Access Control in a Box) is a comprehensive and innovative solution that redefines traditional access control systems. This all-in-one box is available in cylindrical, mortise, or RIM exit device options.



TECHNOLOGY



Wi-Fi



Bluetooth



RFID Card



Mobile Access



Cloud-Based



Wiegand

FEATURES

- Comes with one ISK-B300 (Smart Reader Controller), one electric strike, one Wi-Fi Gateway, one pair of Door Position Sensors, 2 each RFID Fobs & Stickers, and one Plug-in Power Supply
- Convenient electronic locking/unlocking both remotely and on-site, reducing risk of lost keys
- Offers a seamless access control experience and simple, straightforward installation.
- Easily monitor door position and set scheduled privacy and passage modes
- INOX ACBX enhances overall security while offering convenience and ease of use

PRODUCT SERIES

AX-SCI

Cylindrical Strike Box

AX-SMI

Mortise Strike Box

AX-SRI

RIM Exit Device Box

SPECIFICATIONS

Keypad	Backlit Digital Touchscreen
Style	Mullion
Frequency	125KHz / 13.56MHz
Input Voltage	12/24 V DC
RF Output	13.56MHz or 125kHz (reader) 26-Bit Wiegand
Read Interface	EM / Mifare
Read Range	~3/4" to 2-1/2"
Working Current	<80mA (12V) ~ <40mA (24V)
Idle Current	<30mA (12V) ~ <20mA (24V)
Pin Length	4-8 digits
User Capacity	2000 Total (1000 RFID/Passcode + 1000 Mobile)
Working Humidity	0% to 98%
Working Temp.	-20°F to 140°F
Dimensions	5-7/8" x 1-3/4" x 7/8" (150mm x 44mm x 22mm)
Material	Die Cast Metal

BOX OPTIONS

AX-SC1
CYLINDRICAL STRIKE BOX



Grade 1 Electric Strike for Cylindrical Locksets



Reader / Controller with Digital Keypad



Plug-in Gateway



Plug-in Power with 3 Molex Connectors



RFID Fobs & Stickers



Door Position Sensor (DPS) for Wood & Metal Doors & Frames

AX-SM1
MORTISE STRIKE BOX



Grade 1 Electric Strike for Mortise Locksets



Reader / Controller with Digital Keypad



Plug-in Gateway



Plug-in Power with 3 Molex Connectors



RFID Fobs & Stickers



Door Position Sensor (DPS) for Wood & Metal Doors & Frames

AX-SR1
RIM EXIT DEVICE BOX



Grade 1 Electric Strike for RIM Exit Devices



Reader / Controller with Digital Keypad



Plug-in Gateway



Plug-in Power with 3 Molex Connectors



RFID Fobs & Stickers



Door Position Sensor (DPS) for Wood & Metal Doors & Frames

SMART READER CONTROLLER KIT

This thoughtfully designed package empowers users to upgrade their existing door systems, enabling convenient electronic unlocking and locking both remotely and on-site.



TECHNOLOGY



Wi-Fi



Bluetooth



RFID Card



Mobile Access



Cloud-Based



Wiegand

FEATURES

- Comes with one ISK-B300 (Smart Reader Controller), one Wi-Fi Gateway, pair of Door Position Sensors, RFID Fobs & Stickers, and one Plug-in Power Supply
- Convenient electronic locking/unlocking both remotely and on-site, reducing risk of lost keys
- Offers a seamless access control experience with its integrated components
- Easily monitor door position and set scheduled privacy and passage modes
- Cloud-based Access Control with unlimited scalability with real-time updates and seamless integration

PRODUCT SERIES



AX7001-B300

Smart Reader Controller Kit

SPECIFICATIONS

Keypad	Backlit Digital Touchscreen
Style	Mullion
Frequency	125KHz / 13.56MHz
Input Voltage	12/24 V DC
RF Output	13.56MHz or 125kHz (reader) 26-Bit Wiegand
Read Interface	EM / Mifare
Read Range	~3/4" to 2-1/2"
Working Current	<80mA (12V) ~ <40mA (24V)
Idle Current	<30mA (12V) ~ <20mA (24V)
Pin Length	4-8 digits
User Capacity	2000 Total (1000 RFID/Passcode + 1000 Mobile)
Working Humidity	0% to 98%
Working Temp.	-20°F to 140°F
Dimensions	5-7/8" x 1-3/4" x 7/8" (150mm x 44mm x 22mm)
Material	Die Cast Metal

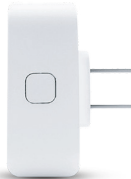
SMART READER CONTROLLER KIT

IMAGE	DESCRIPTION	SPECIFICATIONS
	<p>Reader Controller with Digital Keypad</p>	<ul style="list-style-type: none"> • Voltage 12/24V AC/DC • Current draw 80mA at 12V and 40mA at 24V • Reading Range of 3/4" to 2-1/4" • Pin length; 4 ~ 8 digits • RFID Mifare 13.56MHz
	<p>Plug-in Gateway</p>	<ul style="list-style-type: none"> • Plug-in 110V~220V Outlet (110V US outlet) • For best performance/reliability, connect one device per gateway. • Range: Keep gateway within 10 ft of router and lock. (If obstacles are present, reduce distance to 6 ft.)
	<p>Door Position Sensor (DPS) (Left: Wood doors) (Right: Metal doors)</p>	<ul style="list-style-type: none"> • Maximum Voltage 100V AC/DC • Current draw 0.5mA • Wood doors: Reading Range of 1/2" to 1" • Metal doors: Reading Range of 1" to 1-3/8"
	<p>Plug-in power with 3 Molex connectors</p>	<ul style="list-style-type: none"> • Plug into any standard 110V outlet • Comes standard with 3 Molex connectors • DC Power Cord is 6.5 feet • Power up to 1 AMP
	<p>RFID FOBs and Stickers</p>	<ul style="list-style-type: none"> • For use with 13.56MHz RFID Reader • Needs no additional encoder equipment • Add, edit or remove credentials through App • Assign permissions with customized schedules

PLUG-IN GATEWAY

A compact plug-in gateway signaler that allows access control from anywhere with a functioning Wi-Fi signal.



DIMENSIONS

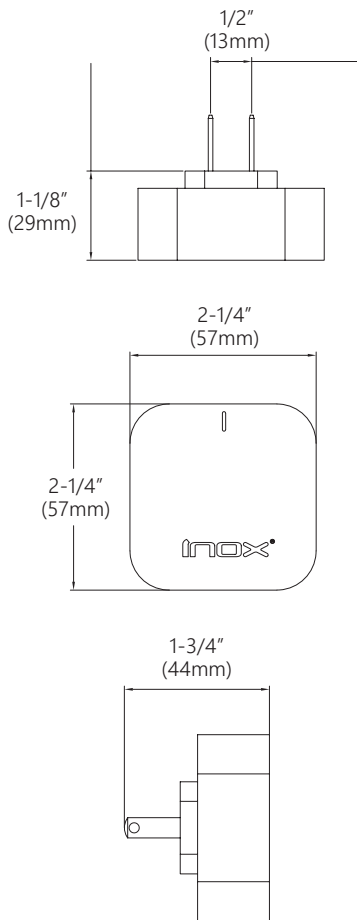

FEATURES

- The gateway can be plugged into any standard 110V outlet
- Supports several smart devices simultaneously; however, for optimal performance, it is recommended to connect only one device per gateway
- The gateway enables remote access via the INOX App when connected to 4G, 5G, or the Internet
- Requires a 2.4 GHz network for connectivity
- Keep the gateway within 10 feet of the router and the lock device, with a maximum open range of 30 feet with a clear line of sight. If obstacles (walls or furniture) are present, reduce the distance to 6 feet or less.

SPECIFICATIONS

Communication Protocol	BLU: Bluetooth Wi-Fi: Wireless
Protocol Specs	BLU: 4.2, 802.11n Wi-Fi: 802.11bgn
Wi-Fi LED (Red)	Blinking: Configuration mode Off: No network connection On: Connected to network
Pairing LED (Blue)	Blinking: Adding sub-device mode On: Gateway configured Press and hold the button for 5 seconds until the red LED blinks, the gateway will enter the configuration mode.
Power Input	110V~220V (110V US Outlet)
Operating Temperature	14°F to 122°F
Dimension	2.2" L x 2.2" W x 0.9" H

PRODUCT SERIES

ISGW-BLE21

If configuring Inox Smart Lock/Gateway with a Wifi Network with a Security Barrier (such as a firewall), please contact INOX Smart Technical Support for Port Forwarding Information.

SMART POE GATEWAY

(MICRO-USB)

Compact gateway that delivers Cloud-based access management.



DIMENSIONS

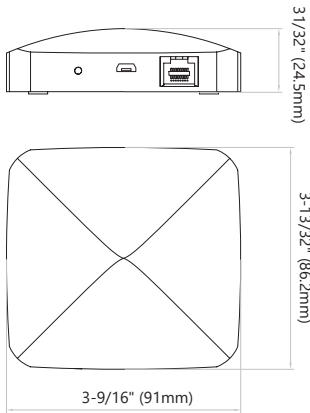

SPLITTER CABLE

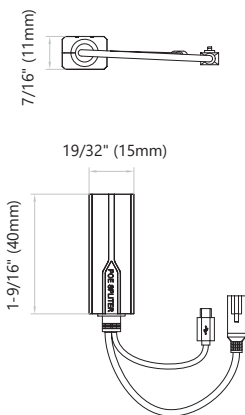

PRODUCT SERIES

ISGW-BP22-SP-WH

FEATURES

- Gateway is hardwired to router via ethernet cable
- Supports several smart devices simultaneously, however for optimal performance it is recommended to connect only one device per gateway
- The gateway enables remote access via the INOX Smart App when connected to 4G, 5G, or Internet
- Communicates in near proximity to INOX Smart Locks using Bluetooth Low Energy (BLE)

SPECIFICATIONS

Type	BLE-POE, Power Over Ethernet
Power Input	DC 5V 1A
Communication Method	Wi-Fi, Ethernet, Bluetooth Mesh
Read Range	25'~ 30'
Working Humidity	10% to 90% RH (no condensation)
Operating Temperature	-4° to 133°F
Storage Temperature	41° to 113°F

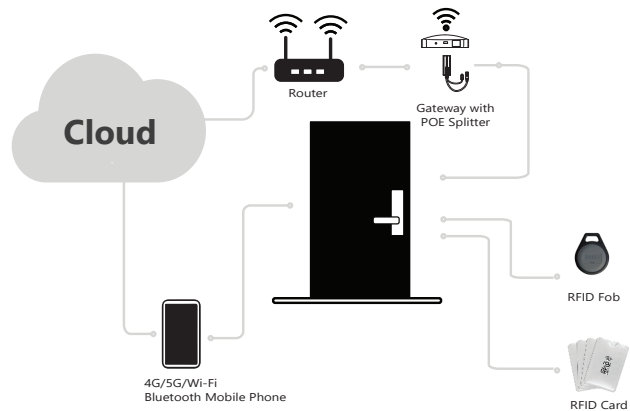

SMART POE GATEWAY

(USB TYPE C)

Compact PoE gateway that delivers Cloud-based access management.



DIMENSIONS

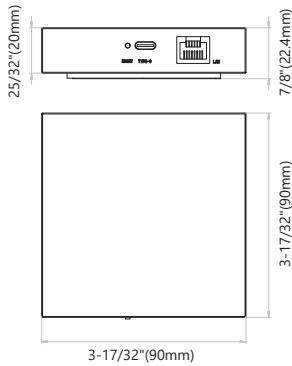

SPLITTER CABLE

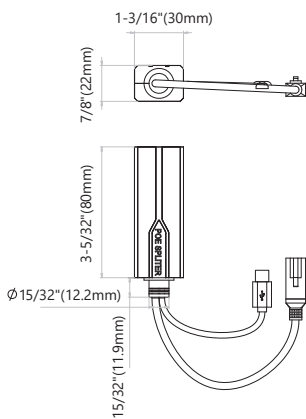

PRODUCT SERIES

ISGW-BP22C-SP-WH

FEATURES

- Uses Wi-Fi, Ethernet, SigMesh, Beacon Mesh, and point-to-point communication
- Supports several smart devices simultaneously, however for optimal performance it is recommended to connect one device per gateway
- The gateway enables remote access via the INOX Smart App when connected to 4G, 5G, or Internet
- By connecting to the gateway, users can remotely view and control smart devices through a mobile app or cloud platform

SPECIFICATIONS

Product Type	Smart Bluetooth Gateway
Connectivity	Wi-Fi, Ethernet, Bluetooth
Wireless Standards	Wi-Fi 2.4 GHz (802.11 b/g/n), Bluetooth 5.1
Control & Access	Remote device monitoring and control via app or cloud
Wireless Range	Long-range coverage for large spaces
Power Supply	5V / 1A (Adapter or Power over Ethernet)
Physical Design	Compact, low-profile housing
Dimensions	90 × 90 × 22 mm (3.54 × 3.54 × 0.86 in)
Operating Conditions	Designed for indoor use across a wide temperature/humidity range
Certifications	CE, FCC, RoHS, REACH compliant

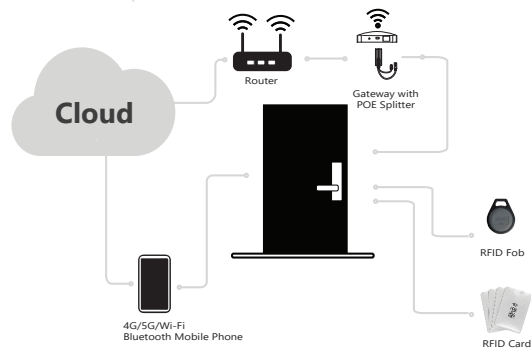

DOOR POSITION SENSORS

WOOD/METAL DOORS & FRAMES

A magnetic-based sensor to report the status of a door (open/closed)



DIMENSIONS

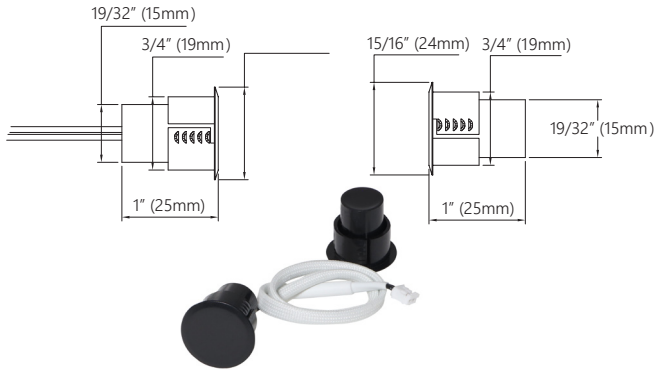

SPECIFICATIONS

Dimensions	0.75" x 0.96" (19mm x 24.5mm)
Maximum Voltage	100V AC/DC
Current Draw	0.5mA
Signal Output	Normally Closed (NC)
	Normally Open (NO)
	Common (COM)
Reading Range	1" to 1-3/8" (2.54cm to 3.5cm)
Installation	Concealed Mounting
Appearance	Black Finish

PRODUCT SERIES

DPS-ISK-M-BK
For Metal Doors and Metal Door Frames

DIMENSIONS

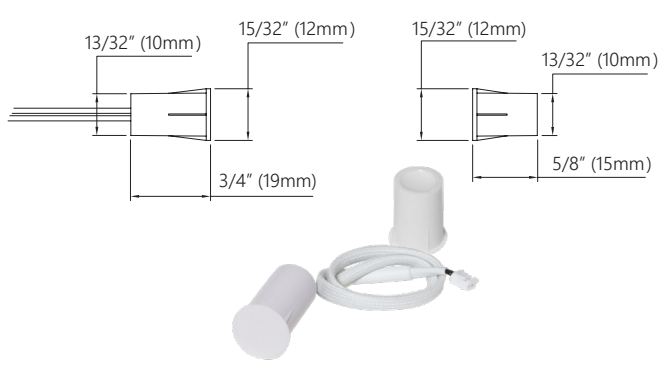

SPECIFICATIONS

Dimensions	0.47" x 0.73" (12mm x 18.5mm)
Maximum Voltage	100V AC/DC
Current Draw	0.5mA
Signal Output	Normally Closed (NC)
	Normally Open (NO)
	Common (COM)
Reading Range	1/2" to 1" (1.27cm to 2.54cm)
Installation	Concealed Mounting
Appearance	White Finish

PRODUCT SERIES

DPS-ISK-W-WH
For Wood Doors and Wood Door Frames



InoX

16th & L Multi-Family

Smart Interconnect
Unlocked



Admin
Click to lock

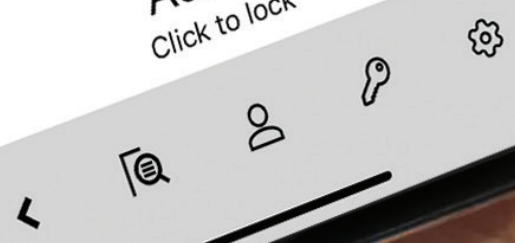

MOBILE FUNCTIONS

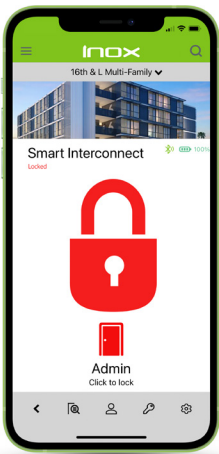

Real-time lock and door status with DPS integration.

- Lock/unlock and open/close status
- Independent lock and door tracking
- Instant visual status confirmation
- DPS-enabled door position feedback
- Improved security visibility

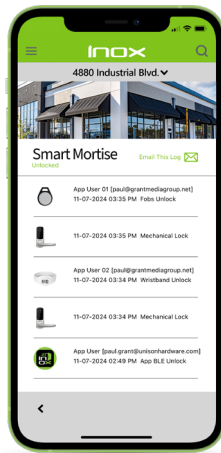
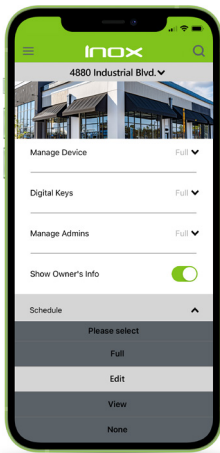
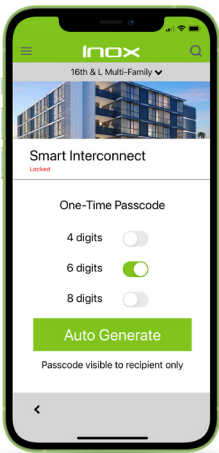

Flexible access control by user, credential, and permission.

- Mobile, PIN, and RFID credentials
- User-based access management
- Custom permission settings
- Time-based access control
- Real-time updates and revocation

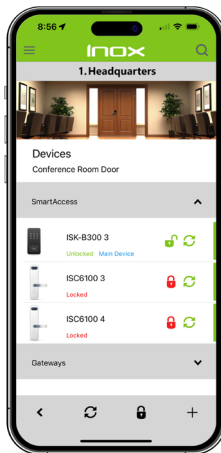
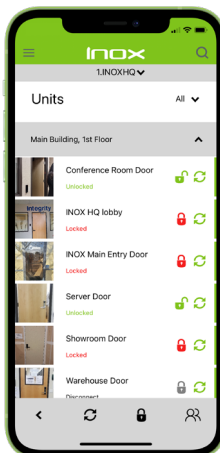
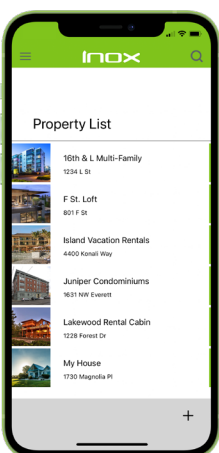

Organized system structure for scalable control.

- Property and unit organization
- Centralized device management
- Multi-location control
- Simplified system setup
- Scalable platform architecture



Download the INOX Smart App today!





PROPERTY MANAGEMENT

Hand out access.
Move people with ease.



EDUCATION

Secure every door.
Focus on what matters most.



OPERATIONS

One dashboard.
Total control.

ACCESS, SIMPLIFIED.

Smart access control for real-world operators.
Simple to use. Powerful to manage.

INOXSmart

BUILT AT THE DOOR, NOT THE PANEL.

Modern security doesn't start in the server room.

It starts at the door.

The INOX Smart web portal is a cloud-based SaaS platform that scales locks, users, and permissions into one intelligent system — eliminating the complexity of traditional access control.



NO PANELS

Eliminate costly infrastructure and maintenance



CLOUD NATIVE

Built for the Cloud
Secure • Reliable • Always on



RAPID DEPLOYMENT

Install faster —
reduced time and labor

1 CENTRALIZED ACCESS MANAGEMENT

- ✓ Instant access assignment & revocation
- ✓ Role-based permissions
- ✓ Multi-site control



2 BATCH ENROLLMENT & MASS PROVISIONING

- ✓ Bulk upload users
- ✓ Eliminate manual setup — reduce hours to minutes
- ✓ Assign access groups at scale

Ideal for:

- Multifamily
- Student housing
- Enterprise



★ FEATURED

1,250
Users
Provisioned



ELIMINATE MANUAL SETUP — REDUCE HOURS TO MINUTES

3 CREDENTIAL FLEXIBILITY

- Mobile (BLE)
- RFID (MIFARE / DESFire)
- PIN
- Optional biometrics

4 REAL-TIME MONITORING

- Live door status
- Event tracking
- Audit logs



5 REMOTE CONTROL & AUTOMATION

- Remote lock/unlock
- Scheduled access
- Emergency lockdown



WHY IT MATTERS



Reduce infrastructure cost by up to **70%**



Deploy faster with minimal wiring



Manage access from anywhere



Scale without system redesign

MAKING A SMART SHIFT.

Rethinking Hardwired Access

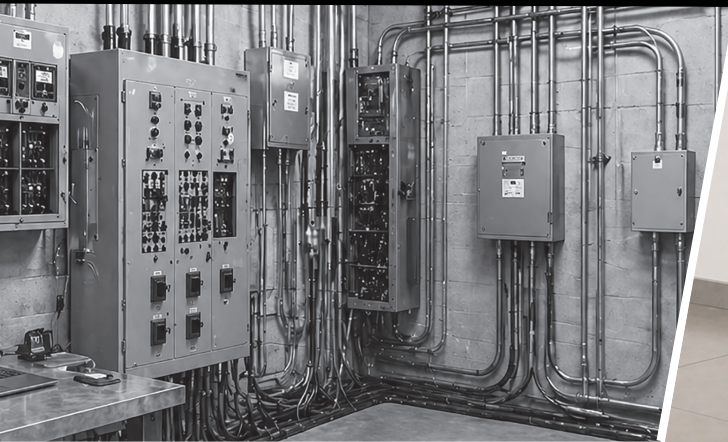

1 THE PROBLEM THE INDUSTRY BUILT IT BACKWARDS

- Centralized panels control every door
- Complex wiring connects everything
- IT systems become a dependency
- Doors are treated as endpoints—not assets

Traditional Model:
Panel → Wiring → Door

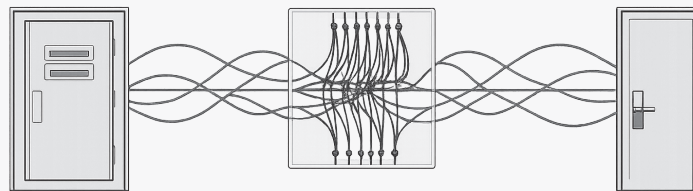

2 THE SHIFT INOX SMART REVERSES THE MODEL

We start at the door.

Every opening becomes:

- ✓ Intelligent
- ✓ Connected
- ✓ Independently controlled

No panel dependency. No unnecessary layers.

INOX Smart Model:
Door → Cloud → Control



A BETTER ARCHITECTURE CHANGES EVERYTHING



For Architects
Simpler specifications,
fewer conflicts



For Developers
Reduced infrastructure
and labor



For Operators
Simplified day-to-day
management



For Integrators
Higher efficiency,
better margins

THIS ISN'T AN UPGRADE. IT'S A NEW FOUNDATION.



INOX SMART WEB PORTAL

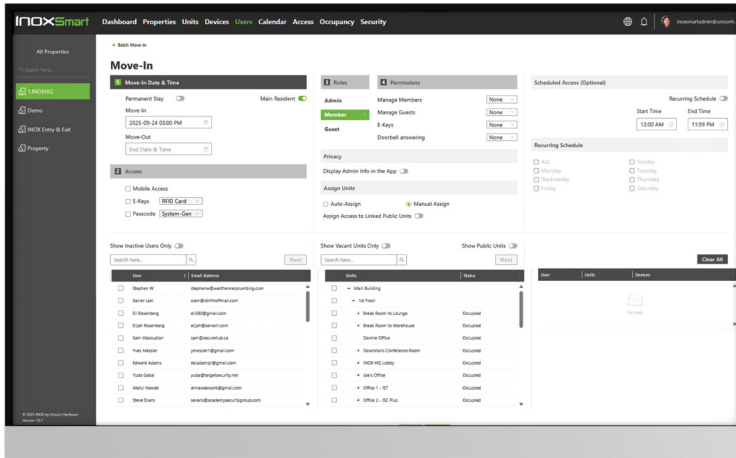

Batch Enrollment

- Bulk onboard tenants and users in minutes with automated scheduling for move-ins and transitions
- Assign credentials, permissions, and access groups at scale across multiple units and properties
- Eliminate manual setup with streamlined workflows that reduce administrative workload

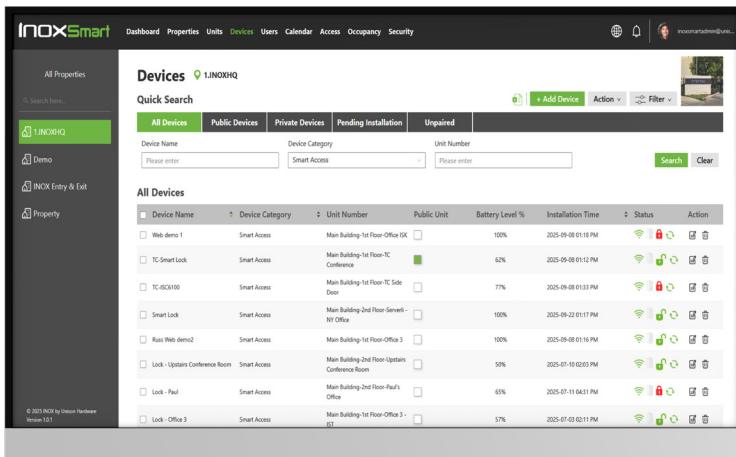

Real Time Monitoring and Access Security

- Instantly lock down all doors system-wide in emergency situations for maximum safety
- Monitor door status, access activity, and events live from a centralized web portal
- Maintain secure environments across schools, healthcare, and multifamily properties with continuous oversight

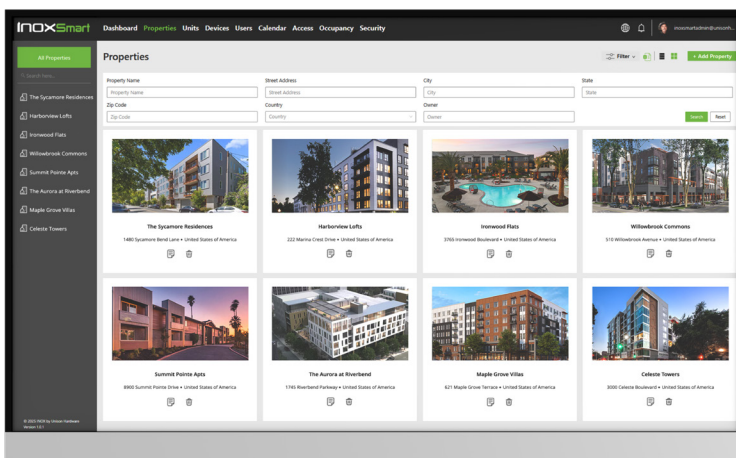

Manage an Entire Portfolio

- Control multiple properties, buildings, and units from one unified platform
- Scale operations effortlessly with enterprise-level management tools and centralized access control
- Support diverse property types—from multifamily and senior living to retail and community facilities



Download the INOX Smart App today!





SMART SOLUTIONS. SECURE SPACES.

INOX Smart delivers innovative, reliable, and easy-to-use access control solutions for residential, commercial, and enterprise environments. Our integrated hardware, free mobile App, and SaaS platform empower you to manage access with confidence—anytime, anywhere.



SECURE & RELIABLE

Enterprise-grade security with encrypted communication and robust hardware built to last



CLOUD-BASED PLATFORM

Manage users, devices, schedules, and reports from our powerful Smart platform.

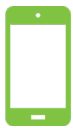

MOBILE ACCESS

Unlock doors and manage access remotely with the Inox Smart App



EASY INTEGRATION

Smart Locks and Access Control devices integrate seamlessly together



REAL-TIME INSIGHTS

Monitor activity, control devices, and make data-driven decisions

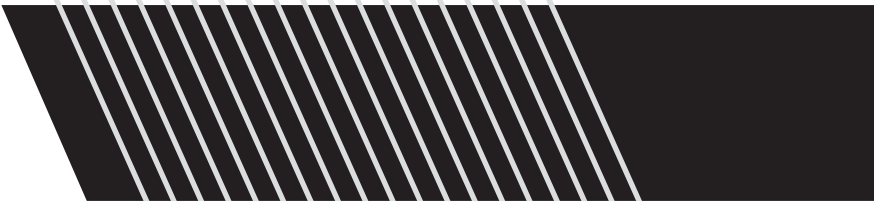

ABOUT INOX SMART

INOX Smart is a division of Unison Hardware, a trusted leader in architectural hardware. With decades of expertise in quality and innovation, we bring smart technology to modern access control—designed for today, built for the future.



TRUSTED EXPERTISE

Backed by years of industry leadership and a commitment to quality.



INNOVATIVE SOLUTIONS

Advanced technology designed to simplify and secure access.



DEDICATED SUPPORT

Our customer support team is standing by to answer your questions



BUILT TO SCALE

Advanced flexible solutions for projects of any size, from small to enterprise.



READY TO GET STARTED?

Contact us today to learn how INOX Smart can transform the way you manage access.



916.388.1888



www.inoxsmart.com



INOX
by Unison Hardware

6 Wayne Ct.,
Sacramento, CA 95829

FOLLOW US



Scan to visit
our website