

Art Deco Tubular Latch

INTERIOR TUBULAR LATCH FOR SWINGING DOORS

Designed to complement the Art Deco collection, this latch set combines refined architectural styling with dependable, commercial-grade performance.

Engineered for seamless integration across INOX hardware for high-end residential and hospitality applications.

CODE COMPLIANCE

- ANSI/BHMA A156.2 Grade 2
- Fire-rated latch tested for UL10B and UL10C to 3 hours
- UBC Standard 7-2 (1997) NFPA 252
- NFPA 80 National Fire Protection - Fire Door Assembly
- NFPA101 National Fire Protection - Life Safety
- ANSI/BHMA A156.18 Finishes
- ANSI A117.1 ADA Accessibility for lever sets (knob sets are not compliant)

FINISHES

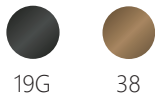

19G

38

ITEM CODES

ADE500L461-19G
ADE500L461-38
ADE500L462-19G
ADE500L462-38
ADE500L471-19G
ADE500L471-38
ADE500L472-19G
ADE500L472-38
ADE500DL-19G
ADE500DL-38
ADE500DL/DR-19G
ADE500DL/DR-38



FEATURES

- Art Deco-inspired design with bold geometry and clean, architectural lines
- Premium latch set construction combining stainless steel or forged brass trim with a commercial-grade tubular latch
- Spring-assisted interlocking chassis engineered for smooth operation and long-term performance
- Designed for high-end residential, mixed-use, and hospitality applications
- Zinc alloy latch stabilizer bracket provides enhanced durability and resistance to heavy torque during 28° latch retraction
- Precision-engineered components ensure reliable functionality and consistent performance
- Supports cohesive specification as part of a complete INOX hardware system
- Durable material and finish options, including 38 Aged Brass and 19G Graphite Black
- Built for both new construction and retrofit installations with standard door preparation compatibility

SPECIFICATIONS

Latch Faceplate	1" x 2-1/4" square corner
Door Thickness	1-3/8"(35mm) to 1-3/4"(44mm) Thick door kits available
Backset	2-3/8" (60mm) 2-3/4" (70mm)
Lever Spindle	8 x 8mm square
Lever Action	28 degree

ART DECO TUBULAR LATCH

FUNCTIONS

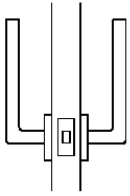

PASSAGE

- Door self-latches when closed
- Both levers always unlocked

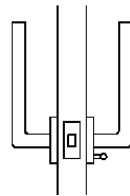

PRIVACY

- Door self-latches when closed
- Door locks when privacy pin is pushed from inside
- Unlock latch by turning inside lever or by emergency release from hole on outside of rose cover



DUMMY

- Outside lever always unlocked; inside, dummy rose only
- Used on pantry or closet if there is no room for an inside lever
- No egress. Do not select this option for spaces in which person could get trapped inside room

STRIKES

All latches come with both T-Strike and Full-lip Strike with square corners. Full-lip Strike with Radius Corner and ASA Strike can be ordered separately.

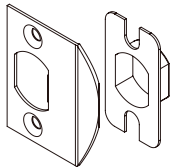

Full-lip Strike
LSR-D1
1-3/4"x2-1/4"

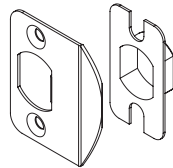

Full-lip Strike 1/4" Corner
LSR-D14
1-3/4"x2-1/4"

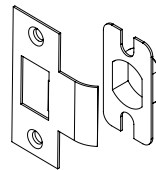

T-Strike
LSR-T1
1-1/8" x 2-3/4"

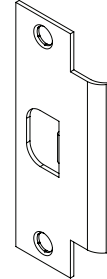

ADA Strike (ANSI Standard)
LSR-ADA
1-1/4"x4-7/8"

DIMENSIONS

ART DECO ROSETTE TUBULAR PRIVACY

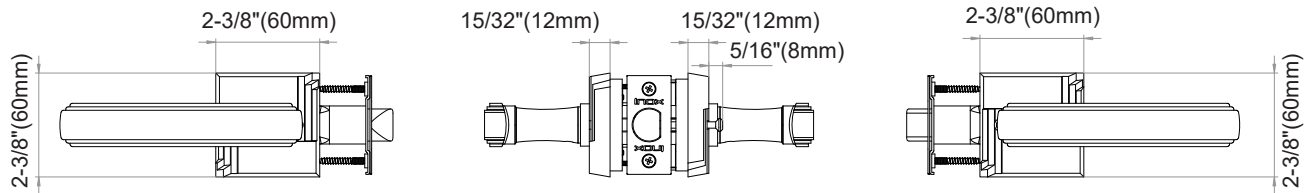

ART DECO ROSETTE TUBULAR PASSAGE

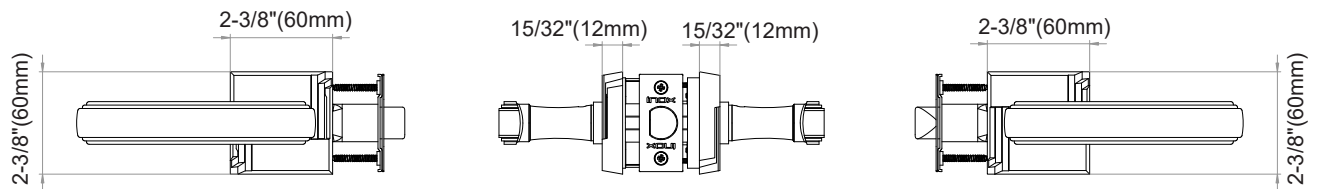

COMPONENTS

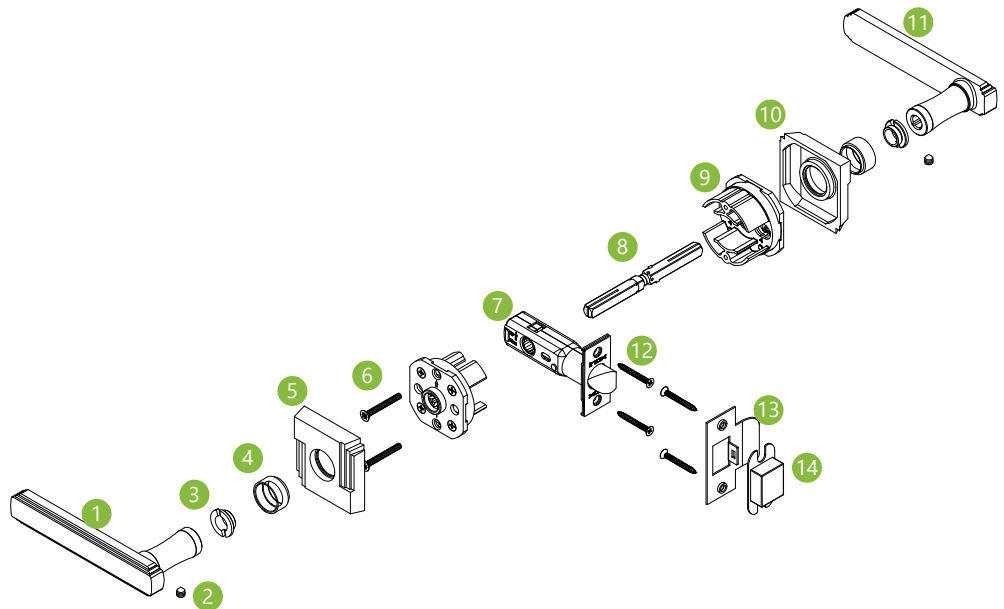

- 1 Interior Lever
- 2 Lever Grub Screw
- 3 Slotted Nut
- 4 Lever Collar
- 5 Interior Art Deco Rosette
- 6 Thru-Bolts
- 7 TL4 Tubular Latch
- 8 Spindle
- 9 Latch Bracket
- 10 Exterior Art Deco rosette
- 11 Exterior Lever
- 12 TL4 Latch Mounting Screws
- 13 Strike Plate
- 14 Dust Box



ART DECO TUBULAR LATCH

HOW TO ORDER

Use the sequence below to order or specify mortise locksets. Please see price book for parts or additional service upcharges.

ROSE	LEVER	FUNCTION	FINISH
ADE	500	L461	38
1	2	3	4
 ADE	 500	 FUNCTION <ul style="list-style-type: none">• L461 Passage, 2-3/8" Backset, TL4 Latch• L462 Privacy, 2-3/8" Backset, TL4 Latch• L471 Passage, 2-3/4" Backset, TL4 Latch• L472 Privacy, 2-3/4" Backset, TL4 Latch• L475 Half Passage, 2-3/4" Backset, TL4 Latch• DL Dummy Left• DR Dummy Right• L761 Passage, 2-3/8" Backset, TL7 Latch• L762 Privacy, 2-3/8" Backset, TL7 Latch• L771 Passage, 2-3/4" Backset, TL7 Latch• L772 Privacy, 2-3/4" Backset, TL7 Latch	

4 FINISHES

- 38 Aged Brass
- 19G Graphite Black