

Smart Locks and Smart Access Control

Commercial, Hospitality, Mixed Use and Residential Applications

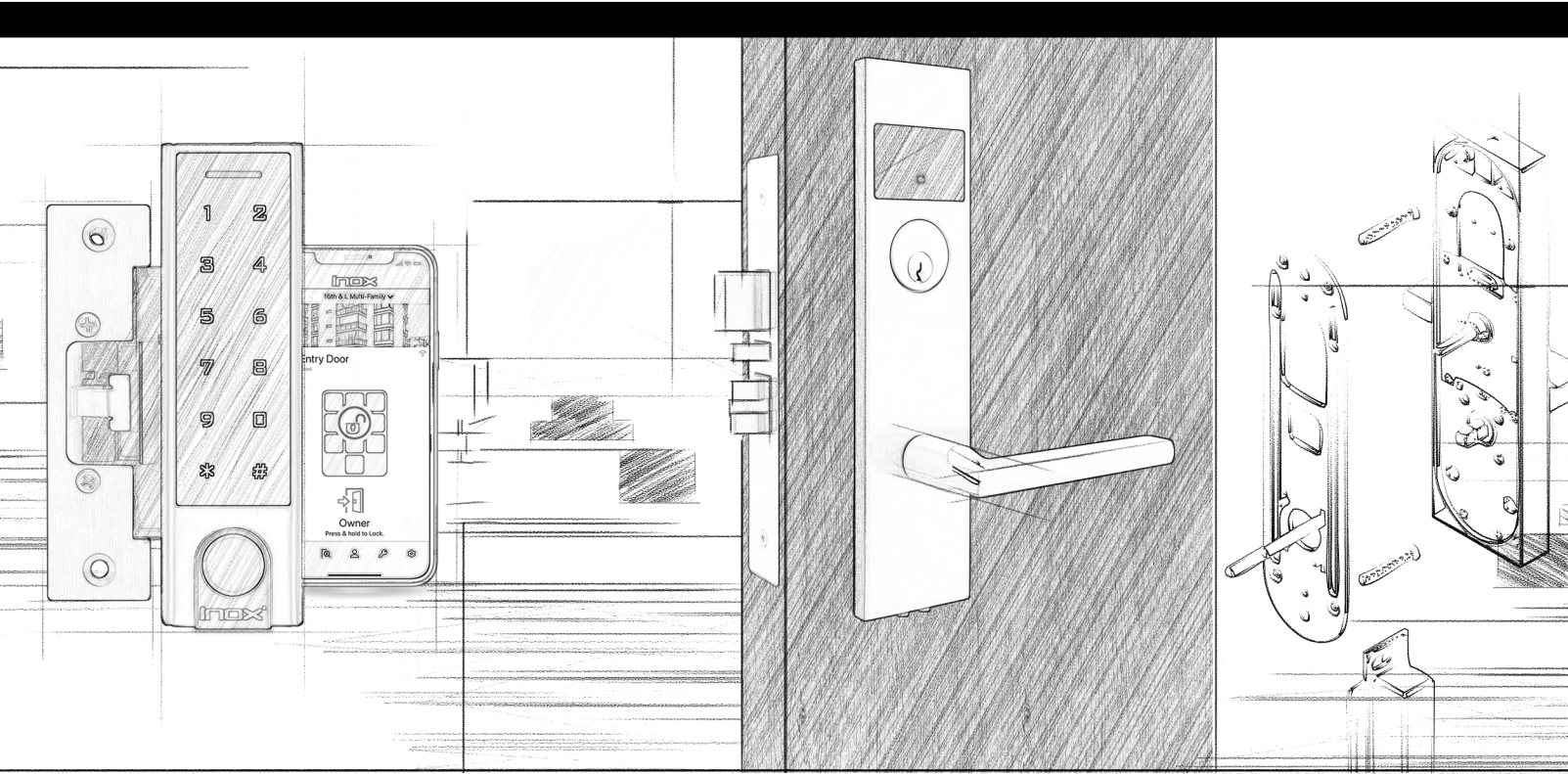

Issue #6.11

Effective Date: 28 April 2025 - Updated: 5/06/2026

UNISON HARDWARE INC.

SMART PRODUCT INTEGRATION SOLUTIONS

ISM-MC7000 Smart Mortise for Swing Doors.....Page 04

ISM-MC7000 Sectional Smart Mortise for Swing DoorsPage 08

ISM-P-VL/VH 9200 Series Smart Trim for Euro Multipoint / Mortise.....Page 12

IST-IC6500 Smart Interconnect for Swing Doors.....Page 14

ISTH Smart Handleset for Swing DoorsPage 18

ISD-BT100 Smart Deadbolt for Swing DoorsPage 20

ISC-CY6200 Cylindrical for Swing DoorsPage 22

ISM-PD9500 Smart Mortise for Sliding Doors.....Page 24

ACBX Access Control in a BoxPage 32

ISK-B300 Smart Reader ControllerPage 34

ISGK-B750 Glass Door Smart LockPage 35

ISED Smart Exit Device Trim.....Page 36

Thick Door Kits.....Page 39

Surface Pulls.....Page 47

IC Cores/Housing.....Page 51

Door Accessories.....Page 56

Finish Price Groups.....Page 63

HandingPage 67

X Series Lever Design Overview

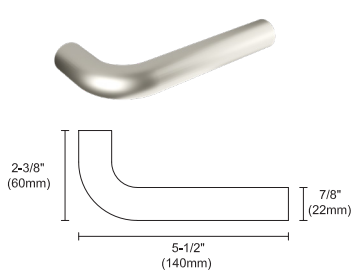

201 Cologne

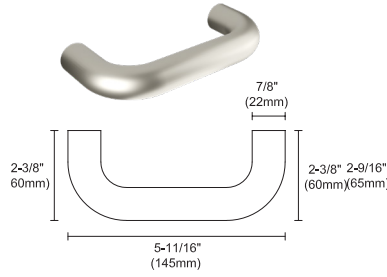

202 Munich

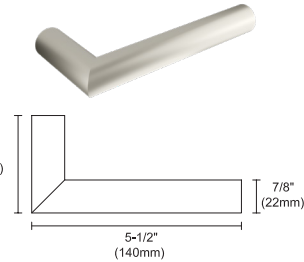

205 Frankfurt

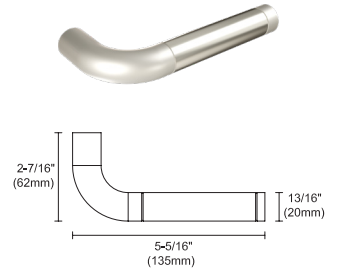

108 Vienna
Available in Q3 2025

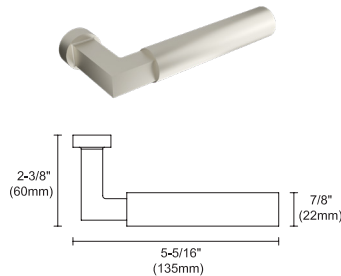

221 Aurora

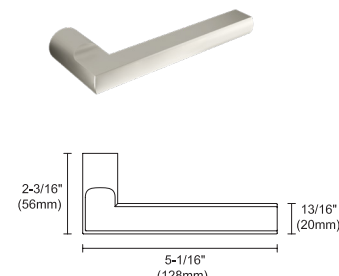

243 Sunrise

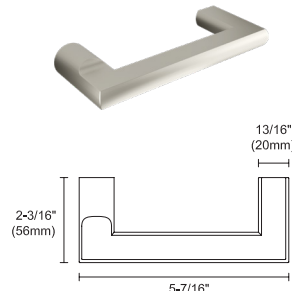

244 Twilight

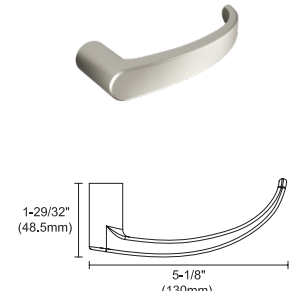

249 Atlanta
Available in Q3 2025

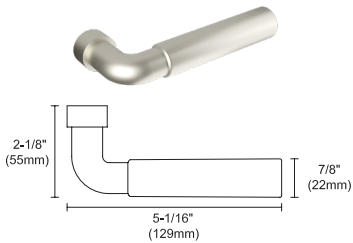

276 Plaza

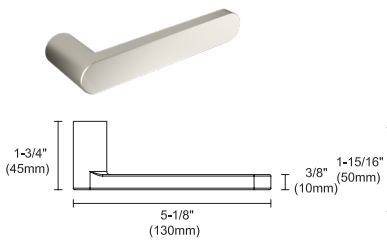

318 Café

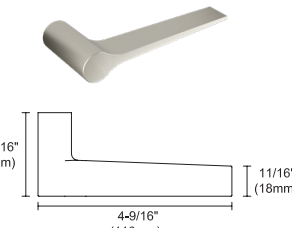

319 Hampton

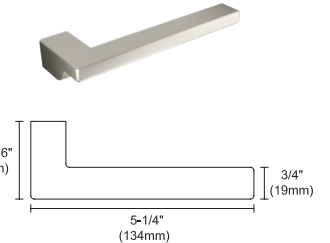

320 Empire

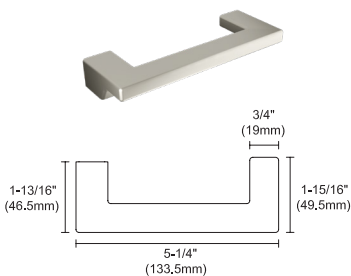

321 Valencia

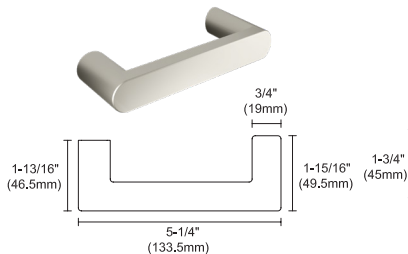

328 Java
Available in Q3 2025

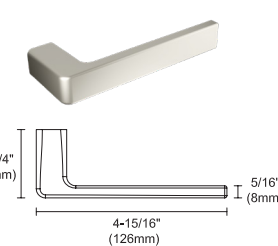

345 Tokyo

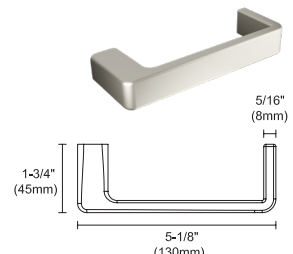

346 Osaka

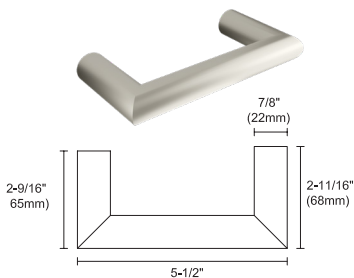

509 Stuttgart

HOW TO ORDER

ISM-SFR Smart Mortise with Reader for Swing Doors

To order locksets, please describe the additional requirements in the same sequence as below. Parts or service upcharge may apply.

INOX Smart Mortise	Plate	Lever	Lock	Bluetooth	Cylinder	Thumbturn	Finish	Handing
ISM	-SFR	243	-MC7438	-BRW			32D	LH
1	2	3	4		5	6	7	8

PLATE



SFR

LEVER

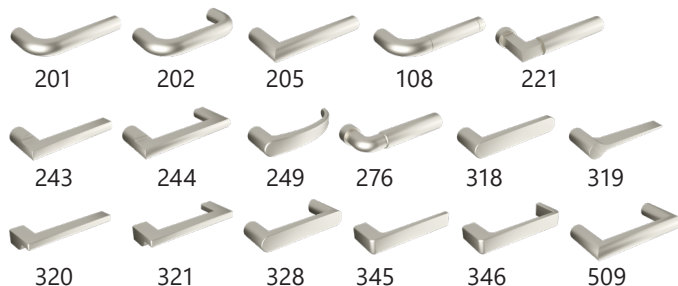

4 LOCK

Deadbolt Entry without Toggle

MDP Mortise Dummy Trim

5 CYLINDER AND HOUSING

LC = Less Cylinder



Blank = Standard Mortise 1-1/4" Cylinder



-S6 = Small Format Interchangeable Cylinder (SFIC) Housing 1-1/4", 6-Pin, Less Core, L Clover Cam

-S7 = Small Format Interchangeable Cylinder (SFIC) Housing 1-3/8", 7-Pin, Less Core, L Clover Cam

-L6 = Large Format Interchangeable Cylinder (LFIC) Housing 1-1/2", 6-Pin, Less Core, L Clover Cam



Order IC Cores and Thick Door Kits (TDKs) separately

6 THUMBTURN



TT02



Blank = TT04

7 FINISH



-32



-32D



-CGY



-C19



-C19G



-19G



-PVD4



-CBB



-CDB

8 HANDING

RH = Right Hand

LH = Left Hand

RHR = Right Hand Reverse

LHR = Left Hand Reverse

ISM-SFR Smart Mortise with Reader Entry Sets

Interior / Exterior Lockset for Swing Doors

Description	Device	Plate	Lever	Lock	Backset	Finish		
						32D	32, 19G, PVD4 ¹	CeraMax ¹
						List Price		
Lockcase, X-Series Lever Design with Smart SFR Trim, Strike, Thumbturn & Cylinder	ISM	SFR	201 Cologne 202 Munich 205 Frankfurt ¹ 221 Aurora ¹ 243 Sunrise ¹ 244 Twilight ¹ 276 Plaza ¹ 318 Café ¹	MC7438	2-3/4"	\$1,488	\$1,538	\$1,868
			319 Hampton ¹ 320 Empire ¹ 321 Valencia ¹ 345 Tokyo ¹ 346 Osaka ¹ 509 Stuttgart ¹	MDP (Dummy Trim)	2-3/4"	\$1,038	\$1,088	\$1,418

¹ **Finish Options**

PVD4 finish available in the 205, 221, 243, 244, 276, 318, 319, 320, 321, 346 and 509 lever design.
 CeraMax Standard Finishes: C19G Graphite Black, C19 Flat Black, CGY Stormy Grey, CDB Dark Bronze, and CBB Burnt Bronze.
 CeraMax coating is applied to the cylinder housing, while the plug will remain in a 15 finish and will not match the housing.

For split finish between outside and inside trim, use higher finish price plus \$30. For orders with LC (Less Cylinder), use list price minus \$50. For order with S6, S7 and L6 housing, use list price plus \$60. Each Entry order includes 2 x RFID FOBS and 2 x RFID Stickers, not available with Dummy Pair. Thick Door Kits (TDKs) available on page 42 - 43.

Exterior and Interior Gaskets are provided as part of the standard offering.

Replacement Weather Gaskets Available		
Weather Seal, ISM Clear Silicon Gasket, Interior	WS-ISM-GASKET-IS	\$10
Weather Seal, ISM Clear Silicon Gasket, Exterior	WS-ISM-GASKET-OS	\$10

HOW TO ORDER

ISM-SFK Smart Mortise with Keypad for Swing Doors

To order locksets, please describe the additional requirements in the same sequence as below. Parts or service upcharges may apply.

INOX Smart Mortise	Plate	Lever	Lock	Keypad	Cylinder	Thumbturn	Finish	Handing
ISM 1	-SFK 2	243 3	-MC7438 4	-BKP	5	6	32D 7	LH 8

PLATE



SFK

LEVER

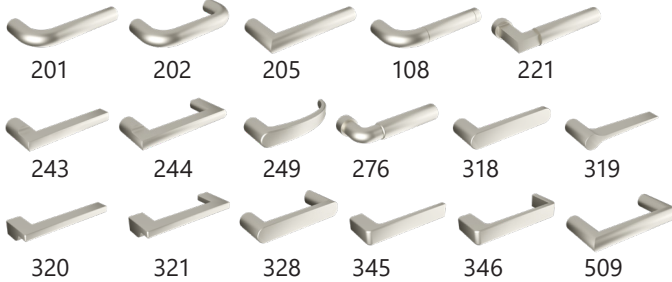

4 LOCK

Deadbolt Entry without Toggle
MDP Mortise Dummy Pair

5 CYLINDER AND HOUSING

LC = Less Cylinder



Blank = Standard Mortise 1-1/4" Cylinder



-S6 = Small Format Interchangeable Cylinder (SFIC) Housing 1-1/4", 6-Pin, Less Core, L Clover Cam

-S7 = Small Format Interchangeable Cylinder (SFIC) Housing 1-3/8", 7-Pin, Less Core, L Clover Cam

-L6 = Large Format Interchangeable Cylinder (LFIC) Housing 1-1/2", 6-Pin, Less Core, L Clover Cam



Order IC Cores and Thick Door Kits (TDKs) separately

6 THUMBTURN



TT02



Blank = TT04

7 FINISH



-32



-32D



-CGY



-C19



-C19G



-19G



-PVD4



-CBB



-CDB

8 HANDING

RH = Right Hand

LH = Left Hand

RHR = Right Hand Reverse

LHR = Left Hand Reverse

ISM-SFK Smart Mortise with Keypad Entry Sets

Interior / Exterior Lockset for Swing Doors

Description	Device	Plate	Lever	Lock	Backset	Finish		
						32D	32, 19G, PVD4 ¹	CeraMax ¹
						List Price		
Lockcase, X-Series Lever Design with Smart SFK Trim, Strike, Thumbturn & Cylinder	ISM	SFK	201 Cologne 202 Munich 205 Frankfurt ¹ 221 Aurora ¹ 243 Sunrise ¹ 244 Twilight ¹ 276 Plaza ¹ 318 Café ¹	MC7438	2-3/4"	\$1,688	\$1,738	\$2,068
			319 Hampton ¹ 320 Empire ¹ 321 Valencia ¹ 345 Tokyo ¹ 346 Osaka ¹ 509 Stuttgart ¹					

¹ Finish Options

PVD4 finish available in the 205, 221, 243, 244, 276, 318, 319, 320, 321, 346 and 509 lever design.
 CeraMax Standard Finishes: C19G Graphite Black, C19 Flat Black, CGY Stormy Grey, CDB Dark Bronze, and CBB Burnt Bronze.
 CeraMax coating is applied to the cylinder housing, while the plug will remain in a 15 finish and will not match the housing.

For split finish between outside and inside trim, use higher finish price plus \$30. For orders with LC (Less Cylinder), use list price minus \$50. For order with S6, S7 and L6 housing, use list price plus \$60. Each Entry order includes 2 x RFID FOBS and 2 x RFID Stickers, not available with Dummy Pair. Thick Door Kits (TDKs) available on page 42 - 43.

Metal Door Position Sensor (DPS) is provided as part of the standard offering.

Exterior and Interior Gaskets are provided as part of the standard offering.

Replacement DPS [Door Position Switch] Sensor Available			
Smart Lock DPS - Round Concealed Mount, Model HC-33A, PH2.0 Plug , For Wood Door, Normally Closed, White		DPS-23W-WH	\$22
Smart Lock DPS - Round Concealed Mount, Model HC-36, PH2.0 Plug , For Metal Door, Normally Closed, Black		DPS-26M-BK	\$22

Replacement Weather Gaskets Available		
Weather Seal, ISM Clear Silicon Gasket, Interior	WS-ISM-GASKET-IS	\$10
Weather Seal, ISM Clear Silicon Gasket, Exterior	WS-ISM-GASKET-OS	\$10

HOW TO ORDER

ISM Smart Sectional Reader Mortise with X-Series Levers for Swing Doors

To order locksets, please describe the additional requirements in the same sequence as below. Parts or service upcharges may apply.

Outside Trim			Inside Trim										
Smart	Rose	Lever	Plate	Lever	Lock	Reader	Bluetooth	Cylinder	Thumbturn	Finish	Handing		
ISM	-XGT	202	-SFR	202	-MC7438	-R1	-BRW	-S6		-32D	-LH		
1	2	3	4	3	5	6		7	8	9	10		

ROSE	LEVER						PLATE	5 LOCK	6 READER
XGT	XGS	201	202	205	108	221	SFR	Deadbolt Entry without Toggle	
		243	244	249	276	318		MDP Mortise Dummy Pair	
		320	321	328	345	346			R1

7 CYLINDER AND HOUSING

LC = Less Cylinder



Blank = Standard Mortise 1-1/4" Cylinder



-S6 = Small Format Interchangeable Cylinder (SFIC) Housing 1-1/4", 6-Pin, Less Core, L Clover Cam

-S7 = Small Format Interchangeable Cylinder (SFIC) Housing 1-3/8", 7-Pin, Less Core, L Clover Cam

-L6 = Large Format Interchangeable Cylinder (LFIC) Housing 1-1/2", 6-Pin, Less Core, L Clover Cam



Order IC Cores and Thick Door Kits (TDKs) separately

8 THUMBTURN



TT02



Blank = TT04

9 FINISH



-32



-32D



-CGY



-C19



-C19G



-19G



-PVD4



-CBB



-CDB

10 HANDING

RH = Right Hand

LH = Left Hand

RHR = Right Hand Reverse

LHR = Left Hand Reverse

ISM Smart Sectional Reader Mortise Entry Sets

Interior / Exterior Lockset for Swing Doors

Description	Device	Rose	Lever	Plate	Lever	Lock	Reader	Bluetooth	Finish		
									32D	32, 19G, PVD4 ¹	CeraMax ¹
									List Price		
Lockcase, X-Series Lever Design with Smart SFR Trim, Strike, Thumbturn & Cylinder	ISM	-XGT -XGS	201		201	MC7438	-R1	-BRW	\$1,488	\$1,538	\$1,828
			202		202						
			205 ¹		205 ¹						
			221 ¹		221 ¹						
			243 ¹		243 ¹						
			244 ¹		244 ¹						
			276 ¹	SFR	276 ¹						
			318 ¹		318 ¹						
			319 ¹		319 ¹						
			320 ¹		320 ¹						
			321 ¹		321 ¹						
			345 ¹		345 ¹						
346 ¹		346 ¹									
509 ¹		509 ¹									

¹ Finish Options

PVD4 finish available in the 205, 221, 243, 244, 276, 318, 319, 320, 321, 346 and 509 lever design.
 CeraMax Standard Finishes: C19G Graphite Black, C19 Flat Black, CGY Stormy Grey, CDB Dark Bronze, and CBB Burnt Bronze.
 CeraMax coating is applied to the cylinder housing, while the plug will remain in a 15 finish and will not match the housing.

For split finish between outside and inside trim, use higher finish price plus \$30. For orders with LC (Less Cylinder), use list price minus \$50. For order with S6, S7 and L6 housing, use list price plus \$60. Each Entry order includes 2 x RFID FOBS and 2 x RFID Stickers, not available with Dummy Pair. Thick Door Kits (TDKs) available on page 42 - 43.

HOW TO ORDER

ISM Smart Sectional Keypad Mortise with X-Series Levers for Swing Doors

To order locksets, please describe the additional requirements in the same sequence as below. Parts or service upcharges may apply.

Outside Trim			Inside Trim			Lock	Keypad	Cylinder	Thumbturn	Finish	Handing
Smart	Rose	Lever	Plate	Lever							
ISM	-XGS	205	-SFK	205	-MC7438	-K1	-S6			-32D	-LH
	1	2	3	2	4	5	6	7	8	9	
rose	LEVER					PLATE	LOCK				
XGT XGS						SFK	Deadbolt Entry without Toggle MDP Mortise Dummy Pair 5 KEYPAD 				

6 CYLINDER AND HOUSING (includes collar)

LC = Less Cylinder

- Blank = Standard Mortise 1-1/4" Cylinder
- S6 = Small Format Interchangeable Cylinder (SFIC) Housing 1-1/4", 6-Pin, Less Core, L Clover Cam
- S7 = Small Format Interchangeable Cylinder (SFIC) Housing 1-3/8", 7-Pin, Less Core, L Clover Cam
- L6 = Large Format Interchangeable Cylinder (LFIC) Housing 1-1/2", 6-Pin, Less Core, L Clover Cam
- Order IC Cores and Thick Door Kits (TDKs) separately

7 THUMBTURN

- TT02
- Blank = TT04

8 FINISH



9 HANDING

RH = Right Hand LH = Left Hand RHR = Right Hand Reverse LHR = Left Hand Reverse

ISM Smart Sectional Keypad Mortise Entry Sets

Interior / Exterior Lockset for Swing Doors

Description	Device	Rose	Lever	Plate	Lever	Lock	Keypad	Finish		
								32D	32, 19G, PVD4 ¹	CeraMax ¹
								List Price		
Lockcase, X-Series Lever Design with Smart SFK Trim, Strike, Thumbturn, & Cylinder	ISM	-XGT -XGS	201		201	MC7438	-K1	\$1,688	\$1,738	\$2,028
			202		202					
			205 ¹		205 ¹					
			221 ¹		221 ¹					
			243 ¹		243 ¹					
			244 ¹		244 ¹					
			276 ¹	SFK	276 ¹					
			318 ¹		318 ¹					
			319 ¹		319 ¹					
			320 ¹		320 ¹					
			321 ¹		321 ¹					
			345 ¹		345 ¹					
			346 ¹		346 ¹					
509 ¹		509 ¹								

¹ Finish Options

PVD4 finish available in the 205, 221, 243, 244, 276, 318, 319, 320, 321, 346 and 509 lever design.

CeraMax Standard Finishes: C19G Graphite Black, C19 Flat Black, CGY Stormy Grey, CDB Dark Bronze, and CBB Burnt Bronze.



CeraMax coating is applied to the cylinder housing, while the plug will remain in a 15 finish and will not match the housing.

For split finish between outside and inside trim, use higher finish price plus \$30. For orders with LC (Less Cylinder), use list price minus \$50. For order with S6, S7 and L6 housing, use list price plus \$60. Each Entry order includes 2 x RFID FOBS and 2 x RFID Stickers, not available with Dummy Pair.

Thick Door Kits (TDKs) available on page 42 - 43.

Metal Door Position Sensor (DPS) is provided as part of the standard offering.

Exterior and Interior Gaskets are provided as part of the standard offering.

Replacement DPS [Door Position Switch] Sensor Available			
Smart Lock DPS - Round Concealed Mount, Model HC-33A, PH2.0 Plug , For Wood Door, Normally Closed, White		DPS-23W-WH	\$22
Smart Lock DPS - Round Concealed Mount, Model HC-36, PH2.0 Plug , For Metal Door, Normally Closed, Black		DPS-26M-BK	\$22

Replacement Weather Gaskets Available		
Weather Seal, ISM Clear Silicon Gasket, Interior	WS-ISM-GASKET-IS	\$10
Weather Seal, Sectional Keypad, Clear Silicon Gasket, Exterior	WS-ISMD-GASKET-OS	\$10

HOW TO ORDER

ISMP-VL/VH 9200 Series Smart Trim for Euro Multipoint / Mortise Lock

To order locksets, please describe the additional requirements in the same sequence as below. Parts or service upcharge may apply.

Smart Multipoint	Plate	Lever	Function/Cylinder	Lever Position	Thumbturn	Finish	Handing
ISMP ①	-MUK ②	243 ③	-MA55 ④	-VL ⑤	⑥	32D ⑦	LH ⑧

③ LEVER

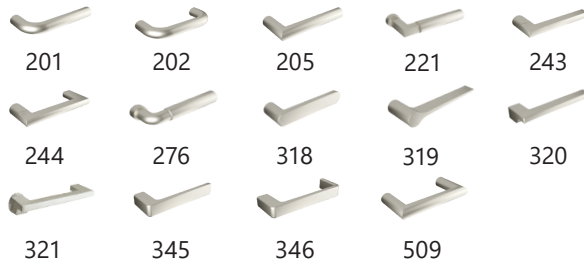

⑤ LEVER POSITION



⑥ THUMBTURN

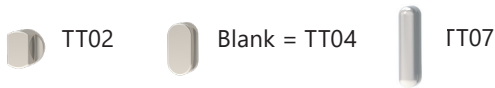

⑦ FINISH



⑧ HANDING

RH = Right Hand LH = Left Hand

ISMP-VL/VH 9200 Series Smart Trim for Euro Multipoint / Mortise Lock

Interior / Exterior Trim for Swing Doors

Description	Device	Plate	Lever	Lever Position	CTC	Finish		
						32D	32, 19G, PVD4 ¹	CeraMax ¹
						List Price		
Smart Multipoint MUK Plate & Keypad	ISMP	MUK	201 Cologne	VH (Level High) VL (Level Low)	3-5/8"	\$898	\$978	\$1,288
			202 Munich					
			205 Frankfurt ¹					
			221 Aurora ¹					
			243 Sunrise ¹					
			244 Twilight ¹					
			276 Plaza ¹					
			318 Café ¹					
			319 Hampton ¹					
			320 Empire ¹					
			321 Valencia ¹					
			345 Tokyo ¹					
346 Osaka ¹								
509 Stuttgart ¹								

HOW TO ORDER

IST Smart Tubular Interconnect with X-Series Levers for Swing Doors

To order locksets, please describe the additional requirements in the same sequence as below. Parts or service upcharges may apply.

INOX Smart Tubular	Plate	Lever	Backset	Cylinder	Center to Center	Thumbturn	Finish	Handing
IST	-SFK	243	-C473FT		-CT5	TT02	32D	LH
1	2	3	4	5	6	7	8	9

PLATE



SFK

LEVER

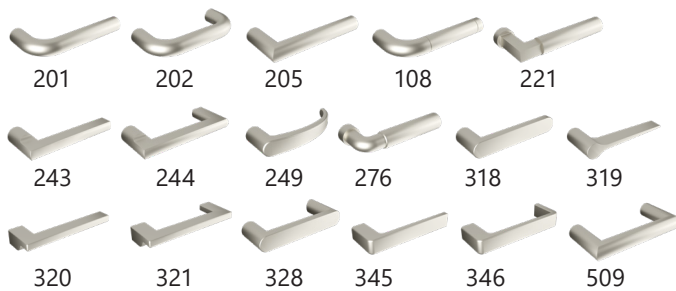

4 BACKSET

C463FT = 2-3/8" Backset (Fire Rated Latch)
C473FT = 2-3/4" Backset (Fire Rated Latch)

5 CYLINDER AND HOUSING (includes collar)

LC = Less Cylinder



Blank = Standard RIM 1" Cylinder (CRB105)

6 CENTER TO CENTER

CT4 = 4" Center to Center
CT5 = 5-1/2" Center to Center

7 THUMBTURN

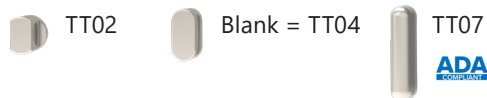

8 FINISH



9 HANDING

RH = Right Hand LH = Left Hand RHR = Right Hand Reverse LHR = Left Hand Reverse

IST Smart Tubular Interconnect Entry Sets

Interior / Exterior Lockset for Swing Doors



Description	Device	Plate	Lever	Backset	CTC	Finish		
						32D	32, 19G, PVD4 ¹	CeraMax ¹
						List Price		
X-Series Lever Design, Smart Trim with Keypad, Deadlatch, TL4 Latch, Strike, Thumbturn & Cylinder	IST	-SFK	201 Cologne 202 Munich 205 Frankfurt ¹ 221 Aurora ¹ 243 Sunrise ¹ 244 Twilight ¹ 276 Plaza ¹ 318 Café ¹	-C463FT -C473FT (Fire Rated)	-CT4 -CT5	\$1,188	\$1,288	\$1,578
			319 Hampton ¹ 320 Empire ¹ 321 Valencia ¹ 345 Tokyo ¹ 346 Osaka ¹ 509 Stuttgart ¹	-TDP (Dummy Trim)	-CT4 -CT5	\$708	\$728	\$1,098

¹ **Finish Options**
 PVD4 finish available in the 205, 221, 243, 244, 276, 318, 319, 320, 321, 346 and 509 lever design.
 CeraMax Standard Finishes: C19G Graphite Black, C19 Flat Black, CGY Stormy Grey, CDB Dark Bronze, and CBB Burnt Bronze.
 CeraMax coating is applied to the cylinder housing, while the plug will remain in a 15 finish and will not match the housing.

For split finish between outside and inside trim, use higher finish price plus \$30. For orders with LC (Less Cylinder), use list price minus \$50. Each order includes 2 x RFID FOBS and 2 x RFID Stickers and not available with Dummy Pair.
 Thick Door Kits (TDKs) available on page 42 - 43.

Metal Door Position Sensor (DPS) is provided as part of the standard offering.

Exterior and Interior Gaskets are provided as part of the standard offering.

Replacement DPS [Door Position Switch] Sensor Available			
Smart Lock DPS - Round Concealed Mount, Model HC-33A, PH2.0 Plug , For Wood Door, Normally Closed, White		DPS-23W-WH	\$22
Smart Lock DPS - Round Concealed Mount, Model HC-36, PH2.0 Plug , For Metal Door, Normally Closed, Black		DPS-26M-BK	\$22



Replacement Weather Gaskets Available		
Weather Seal, IST Clear Silicon Gasket, Interior	WS-IST-GASKET-IS	\$10
Weather Seal, IST Clear Silicon Gasket, Exterior	WS-IST-GASKET-OS	\$10

HOW TO ORDER

IST Smart Sectional Tubular Interconnect with X-Series Levers for Swing Doors

To order locksets, please describe the additional requirements in the same sequence as below. Parts or service upcharges may apply.

Outside Trim			Inside Trim			Backset	Cylinder	Center to Center	Thumbturn	Keypad	Finish	Handing
Smart	Rose	Lever	Plate	Lever								
IST	-SE	243	SFK	243	-C473FT			-CT5		-K1	-32D	-LH
1	2	3	4	3	5	6	7	8	9	10	10	

ROSE	LEVER	PLATE	BACKSET
 RA SE	 221 243 244 276 318 319 320 321 345 346	 SFR	C463FT = 2-3/8" Backset (Fire Rated Latch) C473FT = 2-3/4" Backset (Fire Rated Latch)

6 CYLINDER AND HOUSING (includes collar)

LC = Less Cylinder



Blank = Standard RIM 1" Cylinder (CRB105)

7 CENTER TO CENTER

CT4 = 4" Center to Center

CT5 = 5-1/2" Center to Center

8 THUMBTURN



TT02



Blank = TT04



TT07



9 KEYPAD



K1

10 FINISH



-32



-32D



-CGY



-C19



-C19G



-19G



-PVD4



-CBB



-CDB

11 HANDING

RH = Right Hand

LH = Left Hand

RHR = Right Hand Reverse

LHR = Left Hand Reverse

IST Smart Sectional Tubular Interconnect Entry Sets

Interior / Exterior Lockset for Swing Doors

Description	Device	Rose	Lever	Plate	Lever	Backset	CTC	Finish		
								32D	32, 19G, PVD4 ¹	CeraMax ¹
								List Price		
X-Series Lever Design, Smart Trim with Keypad, Deadlatch, TL4 Latch, Strike, Thumbturn & Cylinder	IST	-SE -RA	201	SFK	201	-C463FT -C473FT (Fire Rated)	-CT4 -CT5	\$1,188	\$1,288	\$1,578
			202		202					
			205 ¹		205 ¹					
			221 ¹		221 ¹					
			243 ¹		243 ¹					
			244 ¹		244 ¹					
			276 ¹		276 ¹					
			318 ¹		318 ¹					
			319 ¹		319 ¹					
			320 ¹		320 ¹					
			321 ¹		321 ¹					
			345 ¹		345 ¹					
346 ¹	346 ¹									
509 ¹	509 ¹									

¹ Finish Options

PVD4 finish available in the 205, 221, 243, 244, 276, 318, 319, 320, 321, 346 and 509 lever design.

CeraMax Standard Finishes: C19G Graphite Black, C19 Flat Black, CGY Stormy Grey, CDB Dark Bronze, and CBB Burnt Bronze.



CeraMax coating is applied to the cylinder housing, while the plug will remain in a 15 finish and will not match the housing.

For split finish between outside and inside trim, use higher finish price plus \$30. For orders with LC (Less Cylinder), use list price minus \$50. Each order includes 2 x RFID FOBS and 2 x RFID Stickers and not available with Dummy Pair.

Thick Door Kits (TDKs) available on page 42 - 43.

Metal Door Position Sensor (DPS) is provided as part of the standard offering.

Exterior and Interior Gaskets are provided as part of the standard offering.

Replacement DPS [Door Position Switch] Sensor Available			
Smart Lock DPS - Round Concealed Mount, Model HC-33A, PH2.0 Plug , For Wood Door, Normally Closed, White		DPS-23W-WH	\$22
Smart Lock DPS - Round Concealed Mount, Model HC-36, PH2.0 Plug , For Metal Door, Normally Closed, Black		DPS-26M-BK	\$22

Replacement Weather Gaskets Available		
Weather Seal, IST Clear Silicon Gasket, Interior	WS-IST-GASKET-IS	\$10
Weather Seal, Sectional Keypad, Clear Silicon Gasket, Exterior	WS-ISMD-GASKET-OS	\$10

HOW TO ORDER

ISTH Smart Tubular Entry Handleset with X-Series Levers for Swing Doors

To order locksets, please describe the additional requirements in the same sequence as below. Parts or service upcharges may apply.

INOX Smart	Handleset	Lever	Backset	Cylinder	Center to Center	Thumbturn	Finish	Handing
ISTH 1	-BWK	243 3	-C573FT 4	5	-CT5 6	TT02 7	32D 8	LH 9

HANDLESET LEVER

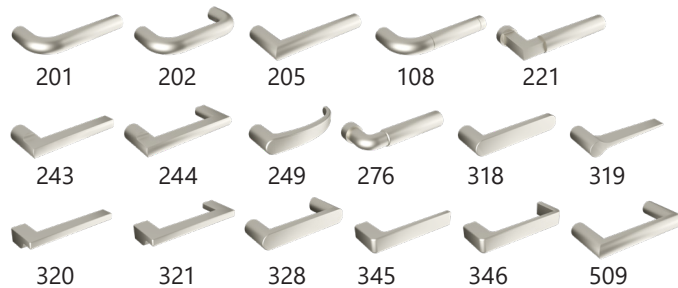

4 BACKSET

C563FT = 2-3/8" Backset (Fire Rated Latch)
C573FT = 2-3/4" Backset (Fire Rated Latch)

5 CYLINDER AND HOUSING (includes collar)

LC = Less Cylinder



Blank = Standard RIM 1" Cylinder (CRB105)

6 CENTER TO CENTER

CT5 = 5-1/2" Center to Center

7 THUMBTURN



TT02



Blank = TT04



TT07



8 FINISH



-32



-32D



-CGY



-C19



-C19G



-19G



-PVD4



-CBB



-CDB

9 HANDING

RH = Right Hand

LH = Left Hand

RHR = Right Hand Reverse

LHR = Left Hand Reverse

ISTH Smart Tubular Entry Handlesets

Interior / Exterior Lockset for Swing Doors

Description	Device	Handleset	Lever	Backset	Finish			
					32D	32, 19G, PVD4 ¹	CeraMax ¹	
					List Price			
Interconnect (Emergency Egress Option)								
X-Series Lever Design, Smart Handleset with Keypad, Interior Interconnect with Emergency Egress , Deadlatch, TL4 Latch, Strike, Thumbturn & Cylinder	ISTH	-BWK	201 202 205 ¹ 221 ¹ 243 ¹ 244 ¹ 276 ¹	318 ¹ 319 ¹ 320 ¹ 321 ¹ 345 ¹ 346 ¹ 509 ¹	-C563FT / -C573FT (Fire Rated)	\$1,488	\$1,588	\$1,888
					-TDP (Dummy BWK Trim)	\$1,188	\$1,288	\$1,588
					-C563FT / -C573FT (Fire Rated)	\$1,288	\$1,388	\$1,688
					-TDP (Dummy HUK Trim)	\$988	\$1,088	\$1,388
		-HUK	-SE -RA	201 202 205 ¹ 221 ¹ 243 ¹ 244 ¹ 276 ¹ 318 ¹ 319 ¹ 320 ¹ 321 ¹	-C563FT / -C573FT (Fire Rated)	\$1,288	\$1,388	\$1,688
					-TDP (Dummy BWK Trim)	\$988	\$1,088	\$1,388
					-C563FT / -C573FT (Fire Rated)	\$1,088	\$1,188	\$1,488
					-TDP (Dummy HUK Trim)	\$888	\$988	\$1,288
Sectional Handleset (Non Emergency Egress Option)								

¹ Finish Options
PVD4 finish available in the 205, 221, 243, 244, 276, 318, 319, 320, 321, 346 and 509 lever design.
CeraMax Standard Finishes: C19G Graphite Black, C19 Flat Black, CGY Stormy Grey, CDB Dark Bronze, and CBB Burnt Bronze.
CeraMax coating is applied to the cylinder housing, while the plug will remain in a 15 finish and will not match the housing.

For split finish between outside and inside trim, use higher finish price plus \$30. For orders with LC (Less Cylinder), use list price minus \$50. Each order includes 2 x RFID FOBS and 2 x RFID Stickers and not available with Dummy Pair. Thick Door Kits (TDKs) available on page 42 - 43.

Metal Door Position Sensor (DPS) is provided as part of the standard offering. Interior Gasket is provided as part of the standard offering.

Replacement DPS [Door Position Switch] Sensor Available			
Smart Lock DPS - Round Concealed Mount, Model HC-33A, PH2.0 Plug , For Wood Door, Normally Closed, White		DPS-23W-WH	\$22
Smart Lock DPS - Round Concealed Mount, Model HC-36, PH2.0 Plug , For Metal Door, Normally Closed, Black		DPS-26M-BK	\$22

Replacement Weather Gaskets Available		
Weather Seal, IST Clear Silicon Gasket, Interior	WS-IST-GASKET-IS	\$10

HOW TO ORDER ISD Smart Deadbolt for Swing Doors

To order locksets, please describe the additional requirements in the same sequence as below. Parts or service upcharges may apply.

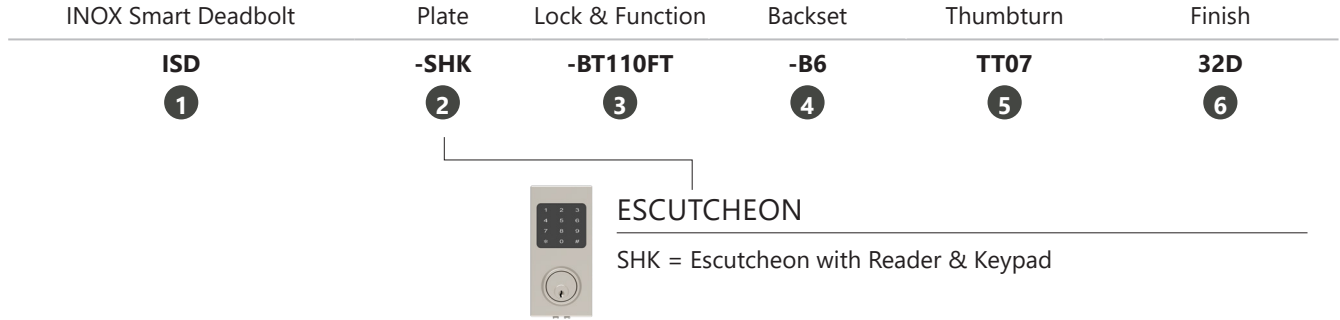

3 LOCK & FUNCTION

-BT110FT = BT Fire-Rated Deadbolt, Single Cylinder Function

4 BACKSET

-B6 = 2-3/8" Backset

-B7 = 2-3/4" Backset

5 THUMBTURN



TT02



Blank = TT04



TT07



6 FINISH



-32



-32D



-CGY



-C19



-C19G



-19G



-PVD4



-CBB



-CDB

ISD Smart Deadbolt Entry Sets

Interior / Exterior Lockset for Swing Doors



Description	Device	Plate	Lock & Function	Backset	Thumbturn	Finish		
						32D	32, 19G, PVD4	CeraMax ¹
						List Price		
6100 Series Entry Lock, Smart Trim with Keypad, Strike, & Cylinder	ISD	-SHK	-BT110FT (Fire Rated)	-B6 -B7	-TT02 -TT04 -TT07	\$528	\$548	\$828

CeraMax Standard Finishes: C19G Graphite Black, C19 Flat Black, CGY Stormy Grey, CDB Dark Bronze, and CBB Burnt Bronze. CeraMax coating is applied to the cylinder housing, while the plug will remain in a 15 finish and will not match the housing.

For split finish between outside and inside trim, use higher finish price plus \$30.
Each order includes 2 x RFID FOBS and 2 x RFID Stickers, and interior and exterior weather gaskets.
Thick Door Kits (TDKs) available on page 42 - 43.

Wood Door Position Sensor (DPS) is provided as part of the standard offering.

Exterior and Interior Gaskets are provided as part of the standard offering.

Replacement DPS [Door Position Switch] Sensor Available			
Smart Lock DPS - Round Concealed Mount, Model HC-33A, PH2.0 Plug , For Wood Door, Normally Closed, White		DPS-23W-WH	\$22
Smart Lock DPS - Round Concealed Mount, Model HC-36, PH2.0 Plug , For Metal Door, Normally Closed, Black		DPS-26M-BK	\$22

Replacement Weather Gaskets Available		
Weather Seal, ISD Clear Silicon Gasket, Interior	WS-ISD-GASKET-IS	\$10
Weather Seal, ISD, Clear Silicon Gasket, Exterior	WS-ISD-GASKET-OS	\$10

HOW TO ORDER ISC Smart Cylindrical for Swing Doors

To order locksets, please describe the additional requirements in the same sequence as below. Parts or service upcharges may apply.

INOX Smart Cylindrical	Plate	Lock & Function	Backset	Cylinder	Finish
ISC 1	-HPK734 2	-CY6153 3	-B6 4	5	26D 6



ESCUTCHEON

HPK = Escutcheon with Reader & Keypad
734 = Kobe 734 Lever

3 LOCK & FUNCTION

-CY6153 = CY Series, Entry

4 BACKSET

- Blank = 2-3/4" Backset (Grade 1)
- B6 = 2-3/8" Backset (Grade 2)

5 CYLINDER AND HOUSING

 Blank = Standard Cylinder

6 FINISH



ISC Smart Cylindrical Entry Sets

Interior / Exterior Lockset for Swing Doors



Description	Device	Plate	Lock & Function	Backset	Finish		
					26D	15, 19G, PVD4	CeraMax ¹
					List Price		
6100 Series Entry Lock, Smart Trim with Keypad, Strike, & Cylinder	ISC	-HPK734	-CY6153	-B6	\$898	\$918	\$1,238

CeraMax Standard Finishes: C19G Graphite Black, C19 Flat Black, CGY Stormy Grey, CDB Dark Bronze, and CBB Burnt Bronze. CeraMax coating is applied to the cylinder housing, while the plug will remain in a 15 finish and will not match the housing.

For split finish between outside and inside trim, use higher finish price plus \$30.
 Each order includes 2 x RFID FOBS and 2 x RFID Stickers, and interior and exterior weather gaskets.
 Thick Door Kits (TDKs) available on page 42 - 43.

Metal Door Position Sensor (DPS) is provided as part of the standard offering.

Exterior and Interior Gaskets are provided as part of the standard offering.

Replacement DPS [Door Position Switch] Sensor Available			
Smart Lock DPS - Round Concealed Mount, Model HC-33A, PH2.0 Plug , For Wood Door, Normally Closed, White		DPS-23W-WH	\$22
Smart Lock DPS - Round Concealed Mount, Model HC-36, PH2.0 Plug , For Metal Door, Normally Closed, Black		DPS-26M-BK	\$22



Replacement Weather Gaskets Available		
Weather Seal, ISC Clear Silicon Gasket, Interior	WS-ISC-GASKET-IS	\$10
Weather Seal, ISC, Clear Silicon Gasket, Exterior	WS-ISC-GASKET-OS	\$10

HOW TO ORDER

ISM-SFR Smart Mortise with Reader for Sliding Doors

To order locksets, please describe the additional requirements in the same sequence as below. Parts or service upcharges may apply.

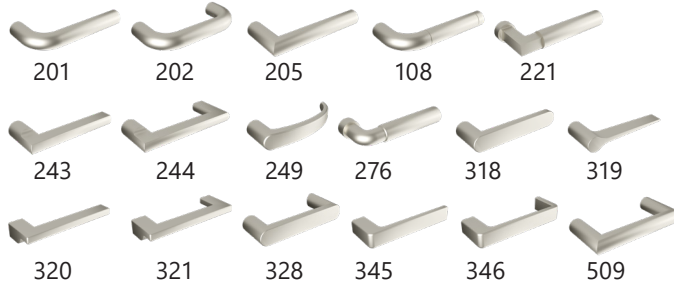
Outside Trim			Inside Trim										
Smart	Rose	Lever	Plate	Lever	Lock	Backset	Reader	Bluetooth	Cylinder	Thumbturn	Finish	Handing	
ISM	-XGT	202	SFR	202	-PD9550	A	-R1	-BRW	-S6		-32D	-LH	
1	2	3	4	3	5	6	7		8	9	10	10	

ROSE	LEVER	PLATE	BACKSET
 XGT XGS	 201 202 205 108 221 243 244 249 276 318 319 320 321 328 345 346 509	 SFR	Backset Blank = 2-3/4" Backset A = 2-1/2"

6 READER

 -R1

7 CYLINDER AND HOUSING (includes collar)

LC = Less Cylinder



Blank = Standard Mortise 1-1/4" Cylinder



-S6 = Small Format Interchangeable Cylinder (SFIC) Housing 1-1/4", 6-Pin, Less Core, L Clover Cam

-S7 = Small Format Interchangeable Cylinder (SFIC) Housing 1-3/8", 7-Pin, Less Core, L Clover Cam

-L6 = Large Format Interchangeable Cylinder (LFIC) Housing 1-1/2", 6-Pin, Less Core, L Clover Cam



Order IC Cores and Thick Door Kits (TDKs) separately

8 THUMBTURN



TT02



Blank = TT04

9 FINISH



-32



-32D



-CGY



-C19



-C19G



-19G



-PVD4



-CBB



-CDB

10 HANDING

RH = Right Hand

LH = Left Hand

ISM-SFR Smart Mortise with Reader for Sliding Locksets

Interior / Exterior Lockset for Sliding Doors

Description	Device	Rose	Lever	Plate	Lever	Lock	Backset	Finish		
								32D	32, 19G, PVD4 ¹	CeraMax ¹
								List Price		
Entry Lockcase, Interior SFK with Lever Design, Exterior Rosette and Lever Design, Sectional Exterior Keypad, Strike Thumbturn & Cylinder	ISM	-XGT -XGS	201	-SFR	201	-PD9550	2-3/4"	\$1,488	\$1,538	\$1,828
			202		202					
			205 ¹		205 ¹					
			221 ¹		221 ¹					
			243 ¹		243 ¹					
			244 ¹		244 ¹					
			276 ¹		276 ¹					
			318 ¹		318 ¹	-PD9550A	2-1/2"	\$1,488	\$1,538	\$1,828
			319 ¹		319 ¹					
			320 ¹		320 ¹					
			321 ¹		321 ¹					
			345 ¹		345 ¹					
			346 ¹		346 ¹					
			509 ¹		509 ¹					

¹ Finish Options

PVD4 finish available in the 205, 221, 243, 244, 276, 318, 319, 320, 321, 346 and 509 lever design.

CeraMax Standard Finishes: C19G Graphite Black, C19 Flat Black, CGY Stormy Grey, CDB Dark Bronze, and CBB Burnt Bronze.

CeraMax coating is applied to the cylinder housing, while the plug will remain in a 15 finish and will not match the housing.

For split finish between outside and inside trim, use higher finish price plus \$30. For orders with LC (Less Cylinder), use list price minus \$50. For order with S6, S7 and L6 housing, use list price plus \$60. Backset Blank = 2-3/4" ; Backset A = 2-1/2". Each Entry order includes 2 x RFID FOBS and 2 x RFID Stickers. Thick Door Kits (TDKs) available on page 42 - 43.

HOW TO ORDER ISM-SFK Smart Mortise with Keypad for Sliding Doors

To order locksets, please describe the additional requirements in the same sequence as below. Parts or service upcharges may apply.

Outside Trim			Inside Trim			Lock	Backset	Keypad	Cylinder	Thumbturn	Finish	Handing
Smart	Rose	Lever	Plate	Lever								
ISM	-XGT	202	SFK	202	-PD9550	A	-K1	-S6			-32D	-LH
1	2	3	4	3	5	6	7	8	9	10	10	

ROSE



XGT XGS

LEVER

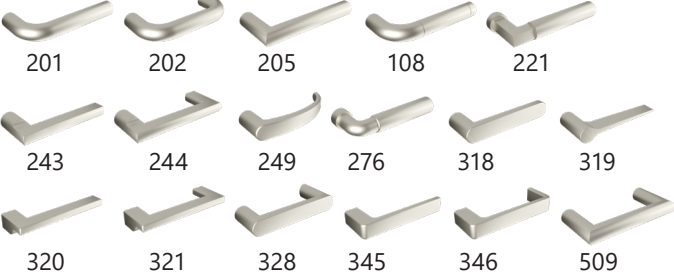

201 202 205 108 221
243 244 249 276 318 319
320 321 328 345 346 509

PLATE



SFK

BACKSET

Backset Blank = 2-3/4"
Backset A = 2-1/2"

6 KEYPAD



-K1

7 CYLINDER AND HOUSING (includes collar)

LC = Less Cylinder



Blank = Standard Mortise 1-1/4" Cylinder



-S6 = Small Format Interchangeable Cylinder (SFIC) Housing 1-1/4", 6-Pin, Less Core, L Clover Cam

-S7 = Small Format Interchangeable Cylinder (SFIC) Housing 1-3/8", 7-Pin, Less Core, L Clover Cam

-L6 = Large Format Interchangeable Cylinder (LFIC) Housing 1-1/2", 6-Pin, Less Core, L Clover Cam



Order IC Cores and Thick Door Kits (TDKs) separately

8 THUMBTURN



TT02



Blank = TT04

9 FINISH



-32



-32D



-CGY



-C19



-C19G



-19G



-PVD4



-CBB



-CDB

10 HANDING

RH = Right Hand

LH = Left Hand

ISM-SFK Smart Mortise with Keypad for Sliding Locksets

Interior / Exterior Lockset for Sliding Doors

Description	Device	Rose	Lever	Plate	Lever	Lock	Backset	Finish				
								32D	32, 19G, PVD4 ¹	CeraMax ¹		
								List Price				
Entry Lockcase, Interior SFK with Lever Design, Exterior Rosette and Lever Design, Sectional Exterior Keypad, Strike Thumbturn & Cylinder	ISM	-XGT -XGS	201	-SFK	201	-PD9550	2-3/4"	\$1,688	\$1,738	\$2,028		
			202		202							
			205 ¹		205 ¹							
			221 ¹		221 ¹							
			243 ¹		243 ¹							
			244 ¹		244 ¹							
			276 ¹		276 ¹							
			318 ¹		318 ¹							
			319 ¹		319 ¹							
			320 ¹		320 ¹							
			321 ¹		321 ¹							
			345 ¹		345 ¹							
			346 ¹		346 ¹							
509 ¹	509 ¹											
								-PD9550A	2-1/2"	\$1,688	\$1,738	\$2,028

¹ **Finish Options**
 PVD4 finish available in the 205, 221, 243, 244, 276, 318, 319, 320, 321, 346 and 509 lever design.
 CeraMax Standard Finishes: C19G Graphite Black, C19 Flat Black, CGY Stormy Grey, CDB Dark Bronze, and CBB Burnt Bronze.
 CeraMax coating is applied to the cylinder housing, while the plug will remain in a 15 finish and will not match the housing.

For split finish between outside and inside trim, use higher finish price plus \$30. For orders with LC (Less Cylinder), use list price minus \$50. For order with S6, S7 and L6 housing, use list price plus \$60. Backset Blank = 2-3/4" ; Backset A = 2-1/2". Each Entry order includes 2 x RFID FOBS and 2 x RFID Stickers. Thick Door Kits (TDKs) available on page 42 - 43.

Metal Door Position Sensor (DPS) is provided as part of the standard offering.

Exterior and Interior Gaskets are provided as part of the standard offering.

Replacement DPS [Door Position Switch] Sensor Available			
Smart Lock DPS - Round Concealed Mount, Model HC-33A, PH2.0 Plug , For Wood Door, Normally Closed, White		DPS-23W-WH	\$22
Smart Lock DPS - Round Concealed Mount, Model HC-36, PH2.0 Plug , For Metal Door, Normally Closed, Black		DPS-26M-BK	\$22

Replacement Weather Gaskets Available		
Weather Seal, ISM Clear Silicon Gasket, Interior	WS-ISM-GASKET-IS	\$10
Weather Seal, ISM Clear Silicon Gasket, Exterior	WS-ISM-GASKET-OS	\$10



















HOW TO ORDER

ISM-SFR Smart Mortise with Reader for Sliding Doors and Surface Pulls Option

Use the sequence below to order or specify mortise locksets.

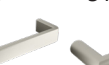
Surface Pull will need to be ordered as a separate line item. Please see price book for list of available pulls.

Outside Trim		Inside Trim									
Smart	Surface Pull	Plate	Lever	Lock	Backset	Reader	Bluetooth	Cylinder	Thumbturn	Finish	Handing
ISM	-PH	-SFR	202	-PD9550	A	-R1	-BRW	-S6		-32D	-LH
1	2	3	4	5	6	7		8	9	10	11

TRIM	LEVER	PLATE	BACKSET
PH - PHIX Pull	 201  202  205  108  221  243  244  249  276  318  319  320  321  328  345  346  509	 SFR	Backset Blank = 2-3/4" Backset A = 2-1/2"
			7 READER
			 -R1

Order surface pull separately - See PHIX page for available pulls and finishes

8 CYLINDER AND HOUSING (includes collar)

LC = Less Cylinder



Blank = Standard Mortise 1-1/4" Cylinder



-S6 = Small Format Interchangeable Cylinder (SFIC) Housing 1-1/4", 6-Pin, Less Core, L Clover Cam

-S7 = Small Format Interchangeable Cylinder (SFIC) Housing 1-3/8", 7-Pin, Less Core, L Clover Cam

-L6 = Large Format Interchangeable Cylinder (LFIC) Housing 1-1/2", 6-Pin, Less Core, L Clover Cam



Order IC Cores and Thick Door Kits (TDKs) separately

9 THUMBTURN



TT02



Blank = TT04

10 FINISH



-32



-32D



-CGY



-C19



-C19G



-19G



-PVD4



-CBB



-CDB

11 HANDING

RH = Right Hand

LH = Left Hand

ISM-SFR Smart Mortise with Reader for Sliding Doors and Surface Pull Option

Interior / Exterior Lockset for Sliding Doors

Description	Device	Trim	Plate	Lever	Lock	Backset	Finish		
							32D	32, 19G, PVD4 ¹	CeraMax ¹
							List Price		
Entry Lockcase, Interior SFR with Lever Design, Round Reader, Strike Thumbturn & Cylinder	ISM	-PH [Surface Pull]	-SFR	201	-PD9550	2-3/4"	\$1,428	\$1,478	\$1,768
				202					
				205 ¹					
				221 ¹					
				243 ¹					
				244 ¹					
				276 ¹	-PD9550A	2-1/2"	\$1,428	\$1,478	\$1,768
				318 ¹					
				319 ¹					
				320 ¹					
				321 ¹					
				345 ¹					
				346 ¹					
				509 ¹					

¹ **Finish Options**
 PVD4 finish available in the 205, 221, 243, 244, 276, 318, 319, 320, 321, 346 and 509 lever design.
 CeraMax Standard Finishes: C19G Graphite Black, C19 Flat Black, CGY Stormy Grey, CDB Dark Bronze, and CBB Burnt Bronze.
 CeraMax coating is applied to the cylinder housing, while the plug will remain in a 15 finish and will not match the housing.

For split finish between outside and inside trim, use higher finish price plus \$30. For orders with LC (Less Cylinder), use list price minus \$50. For order with S6, S7 and L6 housing, use list price plus \$60. Backset Blank = 2-3/4" ; Backset A = 2-1/2". Each Entry order includes 2 x RFID FOBS and 2 x RFID Stickers.

Order surface pull (PHIX) separately as a new line item, see page 34 - 36 for full list of available sizes and finishes.
 Thick Door Kits (TDKs) available on page 42 - 43.



HOW TO ORDER

ISM-SFK Smart Mortise with Keypad for Sliding Doors and Surface Pulls Option

Use the sequence below to order or specify mortise locksets.

Surface Pull will need to be ordered as a separate line item. Please see price book for list of available pulls.

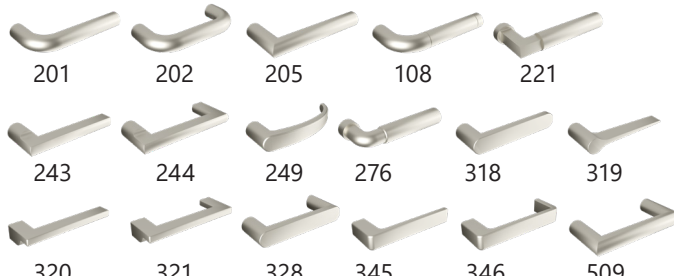
Outside Trim		Inside Trim		Lock	Backset	Keypad	Cylinder	Thumbturn	Finish	Handing
Smart	Surface Pull	Plate	Lever							
ISM	-PH	-SFK	202	-PD9550	A	-K1	-S6		-32D	-LH
1	2	3	4	5	6	7	8	9	10	11

TRIM	LEVER	PLATE	BACKSET
PH - PHIX Pull	 <p>201 202 205 108 221 243 244 249 276 318 319 320 321 328 345 346 509</p>	 <p>SFK</p>	<p>Backset Blank = 2-3/4" Backset A = 2-1/2"</p> <p>7 KEYPAD</p>  <p>-K1</p>

Order surface pull separately - See PHIX page for available pulls and finishes

8 CYLINDER AND HOUSING (includes collar)

LC = Less Cylinder



Blank = Standard Mortise 1-1/4" Cylinder



-S6 = Small Format Interchangeable Cylinder (SFIC) Housing 1-1/4", 6-Pin, Less Core, L Clover Cam

-S7 = Small Format Interchangeable Cylinder (SFIC) Housing 1-3/8", 7-Pin, Less Core, L Clover Cam

-L6 = Large Format Interchangeable Cylinder (LFIC) Housing 1-1/2", 6-Pin, Less Core, L Clover Cam



Order IC Cores and Thick Door Kits (TDKs) separately

9 THUMBTURN



TT02



Blank = TT04

10 FINISH



-32



-32D



-CGY



-C19



-C19G



-19G



-PVD4



-CBB



-CDB

11 HANDING

RH = Right Hand

LH = Left Hand

ISM-SFK Smart Mortise with Keypad for Sliding Doors and Surface Pull Option

Interior / Exterior Lockset for Sliding Doors

Description	Device	Trim	Plate	Lever	Lock	Backset	Finish		
							32D	32, 19G, PVD4 ¹	CeraMax ¹
							List Price		
Entry Lockcase, Interior SFK with Lever Design, Sectional Exterior Keypad, Strike Thumbturn & Cylinder	ISM	-PH [Surface Pull]	-SFK	201	-PD9550	2-3/4"	\$1,628	\$1,678	\$1,968
				202					
				205 ¹					
				221 ¹					
				243 ¹					
				244 ¹					
				276 ¹					
				318 ¹					
				319 ¹					
				320 ¹					
				321 ¹					
				345 ¹					
				346 ¹					
				509 ¹					
							\$1,628	\$1,678	\$1,968



¹ **Finish Options**
 PVD4 finish available in the 205, 221, 243, 244, 276, 318, 319, 320, 321, 346 and 509 lever design.
 CeraMax Standard Finishes: C19G Graphite Black, C19 Flat Black, CGY Stormy Grey, CDB Dark Bronze, and CBB Burnt Bronze.
 CeraMax coating is applied to the cylinder housing, while the plug will remain in a 15 finish and will not match the housing.

For split finish between outside and inside trim, use higher finish price plus \$30. For orders with LC (Less Cylinder), use list price minus \$50. For order with S6, S7 and L6 housing, use list price plus \$60. Backset Blank = 2-3/4" ; Backset A = 2-1/2". Each Entry order includes 2 x RFID FOBS and 2 x RFID Stickers.

Order surface pull (PHIX) separately as a new line item, see page 34 - 36 for full list of available sizes and finishes.
 Thick Door Kits (TDKs) available on page 42 - 43.

Metal Door Position Sensor (DPS) is provided as part of the standard offering.

Exterior and Interior Gaskets are provided as part of the standard offering.

Replacement DPS [Door Position Switch] Sensor Available			
Smart Lock DPS - Round Concealed Mount, Model HC-33A, PH2.0 Plug , For Wood Door, Normally Closed, White		DPS-23W-WH	\$22
Smart Lock DPS - Round Concealed Mount, Model HC-36, PH2.0 Plug , For Metal Door, Normally Closed, Black		DPS-26M-BK	\$22

Replacement Weather Gaskets Available		
Weather Seal, ISM Clear Silicon Gasket, Interior	WS-ISM-GASKET-IS	\$10
Weather Seal, ISM Clear Silicon Gasket, Exterior	WS-ISM-GASKET-OS	\$10

HOW TO ORDER Access Control in a Box [ACBX]

Use the sequence below to order.

Box	Reader/Controller	Gateway	Electric Strike	Power Supply	Door Sensor	Finish
AX	-B30	-W	-SC1	-P13	-D2	-SV
	1	2	3	4	5	6

1 READER / CONTROLLER



-B30 Reader/Controller with digital keypad

Only one unit is included, Silver or Black

2 BLE / WI-FI GATEWAY



-W Plug-in Gateway

3 ELECTRIC STRIKE OPTIONS



-SC1 Grade 1 Electric Strike for Cylindrical Locksets



-SR1 Grade 1 Electric Strike for RIM Exit Device



-SM1 Grade 1 Electric Strike for Mortise Locksets

4 POWER SUPPLY



-P13 Plug-in power with 3 Molex connectors

5 DOOR SENSOR



-D2 Door Position Sensor (DPS)
Both sensors are included

for Wood Doors and Frames



for Metal Doors and Frames

6 FINISH

Standard:





-SV



-BK

Access Control in a Box [ACBX]

Image	Description	Item Code	Finish	
			SV	BK
	<p>Cylindrical Strike Box Grade 1 Cylindrical Electric Strike which includes the Reader Controller with Digital Keypad [ISK-B300]; plug in power with 3 Molex Connectors; BLE/WiFi Gateway*, Door Position Sensors for Wood & Metal Doors; and 2 RFID Fobs /Stickers</p>	<p>AX-B30-W-SC1-P13-D2 [AX-SC1]</p>	\$1,628	\$1,628
	<p>Mortise Strike Box Grade 1 Mortise Electric Strike which includes the Reader Controller with Digital Keypad [ISK-B300]; plug in power with 3 Molex Connectors; BLE/WiFi Gateway*, Door Position Sensors for Wood & Metal Doors; and 2 RFID Fobs /Stickers</p>	<p>AX-B30-W-SM1-P13-D2 [AX-SM1]</p>	\$1,988	\$1,988
	<p>RIM Exit Device Box Grade 1 RIM Exit Device Electric Strike which includes the Reader Controller with Digital Keypad [ISK-B300]; plug in power with 3 Molex Connectors; BLE/WiFi Gateway*, Door Position Sensors for Wood & Metal Doors; and 2 RFID Fobs / Stickers</p>	<p>AX-B30-W-SR1-P13-D2 [AX-SR1]</p>	\$2,288	\$2,288

* Gateway coverage range varies depending on building floor plan, one gateway per device.

ISK-B300 Reader-Controller

Gateway, Electric Strike and Reader-Controller

Image	Description	Item No.	List Price (each)
	Smart Control Keypad Bluetooth with RFID Reader, Narrow (5-7/8" x 2-3/4" x 7/8") Black or Aluminum Housing with Black Touch Screen ²	ISK-B300	\$828
	Universal Door Position Sensor, Round, Concealed Mount with Adapter, Wood, Normally Closed, White	DPS-33A-W-WH	\$22
	Universal Door Position Sensor, Round, Concealed Mount with Adapter, Metal, Normally Closed, Black	DPS-36-M-BK	\$22
	920mm Extension Wires (11 Tails) for ISK-B300	ISK-B300-EXTW	\$30
	Electric Wire, Molex Connector for Electric Strike to connect with PSP Power Supply, 24v	EW-MX3.0-2SM254-2P	\$22
	Electric Wire, ES Latch Bolt Monitoring x ISK Bolt Monitoring	EW-MX3.0-2SM254-2P-BM	\$22
	Plug In Power Supply, 3 2-Pin Molex Connectors, 6.6' DC Cord, Black	PS-3MC-6-BK	\$108
	Smart Gateway ³ , BLE/WIFI, 3 Communication, 1 Power Connection, White (for remote access)	ISGW-BLE21-WH	\$138
	Electric Strike, for Cylindrical Locks, LBM	ES-CY079L-32D	\$618
	Electric Strike, Fire-rated for Mortise Locks, LBM	ES-ML579FL-32D	\$1,078
	Electric Strike, Fire-rated for RIM Exit Device, LBM	ES-ER289FL-32D	\$1,118

ISGK-B750 Smart Glass Door Lock

Image	Description	Item No.	List Price (each)
	INOX Smart Glass Door Lock with Keypad, Fingerprint/PIN/Card/Face Integrated, Compatible with Glass Door 1/2"-3/4" thick, Black Housing, Black Touch Screen	<p style="text-align: center;">ISGK-B750</p>	<p style="text-align: center;">\$788</p>

Door Thickness	Item Code	Description	Price
ISGK-B750 Smart Glass Door Lock TDK			
1/4" to 3/8" (6.5mm to 9.5mm)	<p style="text-align: center;">ISGK-TDK-14-38 with shims</p>	Thin Door Kit for Glass Doors 1/4 - 3/8" Thick. Includes smaller mounting brackets and (2) 4mm thick shims	<p style="text-align: center;">\$98</p>

HOW TO ORDER ISED Smart Exit Device Trim

Use the sequence below to order or specify smart exit device trims.

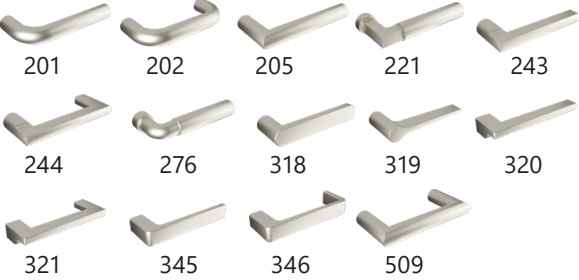
Product	Trim	Lever	Entry Function	Finish	Handing
ISED- 1	ESK 2	243 3	EN- 4	32D- 5	LHR 6
PRODUCT	TRIM	LEVER			
	ESK - RIM Exit Device SVK - SVR Exit Device CVK - CVR Exit Device MDK - MD Exit Device				

5 FINISHES (STANDART)



*Please see Finish Solutions on INOX website for special order finishes.

6 HANDING

RHR – Right Hand Reverse LHR – Left Hand Reverse

ISED Smart Exit Device Trim

for RIM / SVR / CVR / MVR Exit Devices

					Finish			
					32D	19G	Ceramax	
Description	Trim Style	Lever	Function	Handling	List Price			
Entry Interior Battery Box, Exterior Plate Escutcheon with Keypad, Cylinder and Lever Design	ISED-ESK (RIM Trim)	201	EN (Entry)	LHR (Left Hand Revers)	\$1,388	\$1,408	\$1,788	
		202						
		205						
	ISED-SVK (SVR Trim)	221			RHR (Right Hand Revers)	\$1,458	\$1,478	\$1,848
		243						
		244						
		276						
		318						
		319						
	ISED-CVK (CVR Trim)	320				\$1,438	\$1,508	\$1,828
		321						
		345						
		346						
		509						
	ISED-MDK (Mortise Trim)					\$1,438	\$1,508	\$1,828

¹ Finish Options
 CeraMax Standard Finishes: C19G Graphite Black, C19 Flat Black, CGY Stormy Grey, CDB Dark Bronze, and CBB Burnt Bronze.
 CeraMax coating is applied to the cylinder housing, while the plug will remain in a 15 finish and will not match the housing.

RETROFIT COMPATIBILITY CHART

ED93	ALLEGION FALCON	SARGENT	VON DUPRIN	GENERAL LOCK	CAL ROYAL	DETEX
RIM	Compatible After Modifications	Compatible After Modifications	Not Compatible	Fully Compatible	TBD	TBD
MED	Not Compatible	Compatible After Modifications	Fully Compatible	Not Compatible	TBD	TBD
CVR	Compatible After Modifications	Not Compatible	Fully Compatible	Not Compatible	TBD	TBD
SVR	Not Compatible	Not Compatible	Not Compatible	Not Compatible	TBD	TBD

Smart Credentials

RFID E-Keys

Image	Description	Item No.	List Price (each)
	e-Key: RFID Wristband (Green with INOX logo) ⁴	ISEK-R3-W001-GR	\$18
	e-Key: RFID FOB, 2 Pack (Green with INOX logo) ⁴	ISEK-R3-F001-GR	\$24
	e-Key: RFID Sticker, 2 Pack (Green with INOX logo) ⁴	ISEK-R3-S001-GR	\$24
	e-Key: RFID Card (Green with INOX logo) ⁴	ISEK-R3-C001-GR	\$12

⁴ Custom colors or logo available, contact the Sales Department for more information.

Gateways

Image	Description	Item No.	List Price (each)
	Smart Gateway ³ , BLE/WIFI, 3 Communication, 1 Power Connection, White (for remote access)	ISGW-BLE21-WH	\$138
	Smart BLE/POE Gateway With Splitter ³ , with power connection Micro USB/ Ethernet, White (for remote access)	ISGW-BP22-SP-WH	\$348
	Smart BLE/POE Gateway With Splitter, with power connection USB Type-C/ Ethernet, White (for remote access)	ISGW-BP22C-SP-WH	\$348

²Smart Control Keypad is compatible with INOX hardwired electrified hardware. For more information on INOX electrified product, see:

- Mortise Lock catalog (for electrified mortise locks)
- Exit Devices catalog (for electrified trim for exit devices)

³Gateway coverage range varies depending on building floor plan. INOX recommends ordering one gateway per device.

Thick Door Kits [TDK] for Smart Mortise Locks

			Finish		
			32D	32, 19G, PVD4	CeraMax ¹
Door Thickness	Function	Item Code	Price		
SFR and SFK Smart Mortise Set TDKs (MC7000/PD9500)					
2"	Entry	TDK-ISM2-EN 1 x FC-SP8850 Spindle / 1 x FC-SP8860 Spindle / 2 x FS-M6x45-PHL / 1 x FS-M6x35-PHL / 1 x CMB1126 Mortise 1-1/2" Cylinder	\$110	\$122	\$230
2-1/4"	Entry	TDK-ISM214-EN 1 x FC-SP8850 Spindle / 1 x FC-SP8860 Spindle / 2 x FS-M6x55-PHL / 1 x FS-M6x45-PHL / 1 x CMB1126 Mortise 1-1/2" Cylinder	\$110	\$122	\$230
2-1/2"	Entry	TDK-ISM212-EN 1 x FC-SP8860 Spindle / 1 x FC-SP8865 Spindle / 1 x FC-5540CP Spindle / 2 x FS-M6x60-PHL / 1 x FS-M6x50-PHL / 1 x CMB1346 Mortise 1-3/4" Cylinder	\$110	\$122	\$230
2-3/4"	Entry	TDK-ISM234-EN 1 x FC-SP8860 Spindle / 1 x FC-SP8870 Spindle / 1 x FC-5540CP Spindle / 2 x FS-M6x65-PHL / 1 x FS-M6x55-PHL / 1 x CMB1786 Mortise 1-7/8" Cylinder	\$110	\$122	\$230
3"	Entry	TDK-ISM3-EN 1 x FC-SP8865 Spindle / 1 x FC-SP8875 Spindle / 1 x FC-5540CP Spindle / 2 x FS-M6x70-PHL / 1 x FS-M6x60-PHL / 1 x CMB2006 Mortise 2" Cylinder	\$110	\$122	\$230
Sectional Reader Smart Mortise Set TDKs (MC7000/PD9500)					
2"	Entry	TDK-ISM2-SECR1-EN 1 x FC-SP8850 Spindle / 1 x FC-SP8860 Spindle / 1 x FS-M6x35-PHL / 1 x CMB1386 Mortise 1-3/8" Cylinder	\$110	\$122	\$230
2-1/4"	Entry	TDK-ISM214-SECR1-EN 1 x FC-SP8855 Spindle / 1 x FC-SP8865 Spindle / 1 x FC-5540CP Spindle / 2 x FS-M4x40-PHL / 1 x FS-M6x45-PHL / 1 x CMB1126 Mortise 1-1/2" Cylinder	\$110	\$122	\$230
2-1/2"	Entry	TDK-ISM212-SECR1-EN 1 x FC-SP8860 Spindle / 1 x FC-SP8865 Spindle / 1 x FC-5540CP Spindle / 2 x FS-M4x60-PHL / 1 x FS-M6x50-PHL / 1 x CMB1586 Mortise 1-5/8" Cylinder	\$110	\$122	\$230
2-3/4"	Entry	TDK-ISM234-SECR1-EN 1 x FC-SP8860 Spindle / 1 x FC-SP8870 Spindle / 1 x FC-5540CP Spindle / 2 x FS-M4x60-PHL / 1 x FS-M6x55-PHL / 1 x CMB1346 Mortise 1-3/4" Cylinder	\$110	\$122	\$230
3"	Entry	TDK-ISM3-SECR1-EN 1 x FC-SP8865 Spindle / 1 x FC-SP8875 Spindle / 1 x FC-5540CP Spindle / 2 x FS-M4x60-PHL / 1 x FS-M6x60-PHL / 1 x CMB1786 Mortise 1-7/8" Cylinder	\$110	\$122	\$230
Sectional Keypad Smart Mortise Set TDKs (MC7000/PD9500)					
2"	Entry	TDK-ISM2-SECK1-EN 1 x FC-SP8850 Spindle / 1 x FC-SP8860 Spindle / 1 x FS-M6x35-PHL / 1 x CMB1126 Mortise 1-1/2" Cylinder	\$110	\$122	\$230
2-1/4"	Entry	TDK-ISM214-SECK1-EN 1 x FC-SP8855 Spindle / 1 x FC-SP8865 Spindle / 1 x FC-5540CP Spindle / 2 x FS-M4x40-PHL / 1 x FS-M6x45-PHL / 1 x CMB1586 Mortise 1-5/8" Cylinder	\$110	\$122	\$230
2-1/2"	Entry	TDK-ISM212-SECK1-EN 1 x FC-SP8860 Spindle / 1 x FC-SP8865 Spindle / 1 x FC-5540CP Spindle / 2 x FS-M4x60-PHL / 1 x FS-M6x50-PHL / 1 x CMB1346 Mortise 1-3/4" Cylinder	\$110	\$122	\$230
2-3/4"	Entry	TDK-ISM234-SECK1-EN 1 x FC-SP8860 Spindle / 1 x FC-SP8870 Spindle / 1 x FC-5540CP Spindle / 2 x FS-M4x60-PHL / 1 x FS-M6x55-PHL / 1 x CMB1786 Mortise 1-7/8" Cylinder	\$110	\$122	\$230
3"	Entry	TDK-ISM3-SECK1-EN 1 x FC-SP8865 Spindle / 1 x FC-SP8875 Spindle / 1 x FC-5540CP Spindle / 2 x FS-M4x60-PHL / 1 x FS-M6x60-PHL / 1 x CMB2006 Mortise 2" Cylinder	\$110	\$122	\$230



¹ CeraMax Standard Finishes: C19G Graphite Black, C19 Flat Black, CGY Stormy Grey, CDB Dark Bronze, and CBB Burnt Bronze.

Thick Door Kits [TDK] for Smart Tubular Locks

Door Thickness	Function	Item Code	Price
SFK Smart Tubular Sets TDKs			
1-3/8"	Entry	TDK-IST138-EN 1 x FC-SP8850 Spindle / 1 x FC-SPX Spindle	\$55
2" to 2-1/4"	Entry	TDK-IST2-EN 1 x FC-SP8855 Spindle / 1 x FC-SP8865 Spindle / 2 x FS-M5x65-PHL / 1 x TPCY70 Tailpiece	\$55
2-1/4"	Entry	TDK-IST214-EN 1 x FC-SP8855 Spindle / 1 x FC-SP8865 Spindle / 2 x FS-M4x45-PHL / 2 x FS-M5x65-PHL / 1 x TPCY70 Tailpiece	\$55
2-1/2"	Entry	TDK-IST212-EN 1 x FC-SP8860 Spindle / 1 x FC-SP8870 Spindle / 2 x FS-M4x45-PHL / 2 x FS-M5x75-PHL / 1 x TPCY70 Tailpiece	\$55
2-3/4"	Entry	TDK-IST234-EN 1 x FC-SP8865 Spindle / 1 x FC-SP8870 Spindle / 2 x FS-M4x60-PHL / 2 x FS-M5x75-PHL / 1 x TPCY70 Tailpiece	\$55
3"	Entry	TDK-IST3-EN 1 x FC-SP8865 Spindle / 1 x FC-SP8875 Spindle / 2 x FS-M4x60-PHL / 2 x FS-M5x80-PHL / 1 x TPCY70 Tailpiece	\$55
Smart Deadbolt Set TDKs			
2"	Entry	TDK-ISD2-EN 2 x FS-M5x65-PHL / 1 x TPCY70 Tailpiece	\$55
2-1/4"	Entry	TDK-ISD214-EN 2 x FS-M5x65-PHL / 1 x FS-M4x45-PHL / 1 x TPCY70 Tailpiece	\$55
2-1/2"	Entry	TDK-ISD212-EN 2 x FS-M5x75-PHL / 1 x FS-M4x45-PHL / 1 x TPCY70 Tailpiece	\$55
2-3/4"	Entry	TDK-ISD234-EN 2 x FS-M5x75-PHL / 1 x FS-M4x60-PHL / 1 x TPCY70 Tailpiece	\$55
3"	Entry	TDK-ISD3-EN 2 x FS-M5x80-PHL / 1 x FS-M4x60-PHL / 1 x TPCY70 Tailpiece	\$55
Smart Tubular Handleset TDKs			
2"	Entry	TDK-ISTH-BWK2-EN 2x FS-M5x65-PHL/1x FS-M6X55-PHL/1x FC-SP8865 Spindle/1x TPCY70 Tailpiece	\$110
2-1/4"	Entry	TDK-ISTH-BWK214-EN 2x FS-M4x45-PHL/2x FS-M5x65-PHL/1x FS-M6X55-PHL/1x FC-SP8833 Spindle/1x FC-SP8865 Spindle/1x TPCY70 Tailpiece	\$110
2-1/2"	Entry	TDK-ISTH-BWK212-EN 2x FS-M4x45-PHL/2x FS-M5X75-PHL/1x FS-M6x75-PHL/1x FC-SP8833 Spindle/1x FC-SP8870 Spindle/1x TPCY70 Tailpiece	\$110
2-3/4"	Entry	TDK-ISTH-BWK234-EN 2x FS-M4x60-PHL/2x FS-M5X75-PHL/1x FS-M6x75-PHL/1x FC-SP8839 Spindle/1x FC-SP8870 Spindle/1x TPCY70 Tailpiece	\$110
3"	Entry	TDK-ISTH-BWK3-EN 2x FS-M4x60-PHL/2x FS-M5X80-PHL/1x FS-M6x75-PHL/1x FC-SP8839 Spindle/1x FC-SP8875 Spindle/1x TPCY80 Tailpiece	\$110
2"	Entry	TDK-ISTH-HUK2-EN 2x FS-M5x65-PHL/1x FS-M6x35-PHL/1x FS-M6X55-PHL/1x FC-SP8865 Spindle/1x TPCY70 Tailpiece	\$110
2-1/4"	Entry	TDK-ISTH-HUK214-EN 2x FS-M4x45-PHL/2x FS-M5x65-PHL/1x FS-M5x45-PHL/1x FS-M6X55-PHL/1x FC-SP8833 Spindle/1x FC-SP8865 Spindle/1x TPCY70 Tailpiece	\$110
2-1/2"	Entry	TDK-ISTH-HUK212-EN 2x FS-M4x45-PHL/2x FS-M5X75-PHL/1x FS-M6x45-PHL/1x FS-M6x75-PHL/1x FC-SP8833 Spindle/1x FC-SP8870 Spindle/1x TPCY70 Tailpiece	\$110
2-3/4"	Entry	TDK-ISTH-HUK234-EN 2x FS-M4x60-PHL/2x FS-M5X75-PHL/1x FS-M6x60-PHL/1x FS-M6x75-PHL/1x FC-SP8839 Spindle/1x FC-SP8870 Spindle/1x TPCY70 Tailpiece	\$110
2-1/2"	Entry	TDK-ISTH-HUK3-EN 2x FS-M4x60-PHL/2x FS-M5X80-PHL/1x FS-M6x60-PHL/1x FS-M6x75-PHL/1x FC-SP8839 Spindle/1x FC-SP8875 Spindle/1x TPCY80 Tailpiece	\$110

Smart Parts and Services

Rose Covers, Face Plates, Strikes, Thick Door Kits (TDKs), Thin Door Kits, (TDKs)

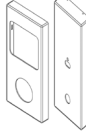
Illustration	Description	Item Code	Finish		
			32D	32, 19G, PVD4	CeraMax ¹
Smart Full Plate Keypad Cover Plates 	SFK Cover for ISM7000 Full Plate Keypad Exterior Plate	PR-SFK76-FINISH	\$204	\$216	\$294
	SFRK Cover for ISM7000 Full Plate Reader/Keypad Interior Plate	PR-SF71-FINISH	\$204	\$216	\$294
Smart Sectional Keypad Cover Plates 	SHK Cover for ISM7000/ISM95 Sectional Keypad Exterior Plate	PR-SHK52-FINISH	\$180	\$192	\$270
	SFRK Cover for ISM7000 Full Plate Reader/Keypad Interior Plate	PR-SF71-FINISH	\$204	\$216	\$294
Smart Full Plate Reader Cover Plates 	SFR Cover for ISM7000 Full Plate Reader Exterior Plate	PR-SFR70-FINISH	\$204	\$216	\$294
	SFRK Cover for ISM7000 Full Plate Reader/Keypad Interior Plate	PR-SF71-FINISH	\$204	\$216	\$294
Smart Deadbolt Cover Plates 	Cover for ISD Sectional Keypad Exterior Plate	PR-SHK50-FINISH	\$180	\$192	\$270
	Cover for ISD Sectional Keypad Interior Plate	PR-SHK51-FINISH	\$180	\$192	\$270
Smart IST Tubular 5-1/2" Cover Plate 	SFK Interconnect 5-1/2" Keypad Exterior Plate	PR-SFK72-FINISH	\$204	\$216	\$294
	SFK Interconnect 5-1/2" Keypad Interior Plate	PR-SFK73-FINISH	\$204	\$216	\$294
Smart IST Tubular 4" Cover Plate 	SFK Interconnect 4" Keypad Exterior Plate	PR-SFK74-FINISH	\$204	\$216	\$294
	SFK Interconnect 5-1/2" Keypad Interior paired with 4" Exterior Plate	PR-SFK73-FINISH	\$204	\$216	\$294
Smart ISC Cover Plate 	HPK Cover Cylindrical with Keypad Exterior Plate	PR-HPK60-FINISH	\$180	\$192	\$270
	HPK Cover Cylindrical Interior Plate	PR-HPK61-FINISH	\$180	\$192	\$270



¹CeraMax Standard Finishes: C19G Graphite Black, C19 Flat Black, CGY Stormy Grey, CDB Dark Bronze, and CBB Burnt Bronze.

Exterior Cover Plates may require removal of outside lever in order to install.

NOTE: Exterior Cover Plates may require removal of outside lever in order to install.

Smart Parts and Services

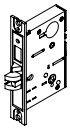
Rose Covers, Face Plates, Strikes, Thick Door Kits (TDKs), Thin Door Kits, (TDKs)

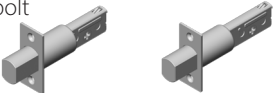
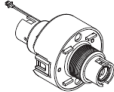



Lockcases/Latches					Finish			
					32D	32, 19G	PVD4	CeraMax ¹
Illustration	Backset	Function	Item Code	Price				
Smart Mortise MC7000 Lockcase								
Entry Lockcase NC- Non Clutch Mortise Lockcase	 2-3/4"	Entry w/o Toggle (7438)	MC738 MC738NC	\$312	\$328	\$343	\$372	
Smart Mortise PD9500 Lockcase								
Entry Lockcase	2-1/2" 2-3/4"	Entry	PD95-212 PD95-234	\$338	\$354	\$369	\$398	
Smart Interconnect Latch and Smart Deadbolt								
TL4, 28 Degree ANSI Grade 2 Latch	 2-3/8" 2-3/4"	Passage	TL461 TL471	\$68	\$77	\$77	\$120	
	2-3/8" 2-3/4"	Passage	TL461F TL471F	\$102	\$109	\$109	\$162	
60mm/70mm Grade 2 "FT" Fire-Rated Taper Deadbolt	 2-3/8" 2-3/4"	Deadlock	BT160FT BT170FT	\$102	\$109	\$109	\$162	
Smart Cylindrical Chassis								
This chassis works for 1-3/8" to 1-3/4" Thick Doors		Deadlatch Bracket	BRIX-ISC-LA01	\$230	N/A	N/A	N/A	

¹CeraMax Standard Finishes: C19G Graphite Black, C19 Flat Black, CGY Stormy Grey, CDB Dark Bronze, and CBB Burnt Bronze.

Smart Parts and Services

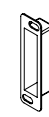

Rose Covers, Face Plates, Strikes, Thick Door Kits (TDKs), Thin Door Kits, (TDKs)

ISM-SFR and ISM-SRK Faceplates and Strikes

			Finish					
			32D	32, 19G	PVD4	CeraMax ¹		
Illustration	Function	Item Code	Price (EA)					
	Smart Entry MC7438)	MC-FSP05	\$22	\$28	\$39	\$62		
Strike and Dustbox								
			MC Mortise Strike	LSR-MC01	\$22	\$28	\$39	\$62
MC Strike	MC Dust Box	Deadbolt Strike	MC Mortise Strike Dust Box	LSR-DBX-MC	\$13	N/A	N/A	N/A
			Mortise Deadbolt Strike	LSR-MC717	\$22	\$28	\$39	\$62

¹CeraMax Standard Finishes: C19G Graphite Black, C19 Flat Black, CGY Stormy Grey, CDB Dark Bronze, and CBB Burnt Bronze.

ISC Faceplates and Strikes

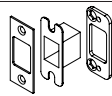
			Finish			
			32D	32, 19G	PVD4	CeraMax ¹
Illustration	Function	Item Code	Price			
	Privacy bolt	PB1-FSP	\$11	\$13	\$13	\$51
	Privacy bolt strike and dust box	LSR-PB1	\$26	\$30	\$30	\$66
	Deadbolt	BT1-FSP	\$11	\$13	\$13	\$51
	Deadbolt Strike w/reinforcement plate and dustbox	LSR-BT1	\$26	\$30	\$30	\$66

¹CeraMax Standard Finishes: C19G Graphite Black, C19 Flat Black, CGY Stormy Grey, CDB Dark Bronze, and CBB Burnt Bronze.

Smart Parts and Services

Rose Covers, Face Plates, Strikes, Thick Door Kits (TDKs), Thin Door Kits, (TDKs)

ISD Faceplates and Strikes

Illustration	Function	Item Code	Finish			
			32D	32, 19G	PVD4	CeraMax ¹
	Privacy bolt	PB1-FSP	\$11	\$13	\$13	\$51
	Privacy bolt strike and dust box	LSR-PB1	\$26	\$30	\$30	\$66
	Deadbolt	BT1-FSP	\$11	\$13	\$13	\$51
	Deadbolt Strike w/reinforcement plate and dust box	LSR-BT1	\$26	\$30	\$30	\$66

¹CeraMax Standard Finishes: C19G Graphite Black, C19 Flat Black, CGY Stormy Grey, CDB Dark Bronze, and CBB Burnt Bronze.







IST-SFK Faceplates and Strikes

Illustration	Function	Item Code	Finish			
			32D	32, 19G	PVD4	CeraMax ¹
TL4 Faceplates 	Standard	TL4-FSP	\$20	\$22	\$22	\$60
	1/4" Radius Corner	TL4-FSP14	\$20	\$22	N/A	\$60
Full-Lip Strikes 	Passage	LSR-D1	\$20	\$22	\$22	\$60
	1/4" Radius Corner	LSR-D14	\$20	\$22	N/A	\$60
T-Strike 	Square Corner	LSR-T1	\$20	\$22	\$22	\$60
ASA Strike 	Square Corner	LSR-ASA	\$27	\$30	\$30	\$67

¹CeraMax Standard Finishes: C19G Graphite Black, C19 Flat Black, CGY Stormy Grey, CDB Dark Bronze, and CBB Burnt Bronze.

Smart Parts and Services

Rose Covers, Face Plates, Strikes, Thick Door Kits (TDKs), Thin Door Kits, (TDKs)

			Finish		
			32D	32, 19G, PVD4	CeraMax ¹
Thumbturns			Price		
Illustration	Function	Item Code			
	Thumbturn for ISD	TT04	\$30	\$45	\$70
	Thumbturn for ISM/IST/ISC	TT04C	\$30	\$45	\$70
	Thumbturn	TT02	\$30	\$45	\$70
	Thumbturn	TT07	\$30	\$45	\$70
	Gasket Washer for Deadbolt Thumbturn	AP-SJ-37	\$5	N/A	N/A
	M6x7mm Set Screws for Thumbturn	JG-10	\$5	N/A	N/A

¹CeraMax Standard Finishes: C19G Graphite Black, C19 Flat Black, CGY Stormy Grey, CDB Dark Bronze, and CBB Burnt Bronze.

Smart Parts and Services

Common Screws, Spindles and Fixing Packs

Spindles

Illustration	Description	Item No.	List (EA)
	Spindle square 8 x 8 x 45mm (For Standard Door Thickness)	FC-SP8845	\$11
	Spindle square 8 x 8 x 55mm (For 2" to 2-1/4" Door Thickness)	FC-SP8855	\$11
	Spindle square 8 x 8 x 65mm (For 2-1/2" to 2-3/4" Door Thickness)	FC-SP8865	\$11
	Spindle square 8 x 8 x 70mm (For 3" Door Thickness)	FC-SP8870	\$20

Common Screws and Parts

Illustration	Screw Type	Application	Item Code	List
	Machine Screws M4x6mm	For MC& MT Mortise Lock Amore Faceplate	FS-M4x6-PHL	\$11
	Machine Screws M4x35mm	All Tubular Levers Sectional Mortise Lever	FS-M4x35-PHL	\$11
	Machine Screws M5x45mm	RD/SD/GD Deadbolt Cylinder	FS-M5x45-PHL	\$11
	Machine Screws M5x50mm	LA/SF Entry Cylinder	FS-M5x50-PHL-2PK	\$11
	Machine Screws M6x45mm	LA/SF Mortise All Functions	FS-M6x45-PHL	\$11
	Allen wrench	All Lever Sets	LJ-04	\$11
	Emergency Release Key	Tubular Privacy Sets	ERK60-ZK	\$11

Above common screws and parts are often lost or accidentally discarded during project installation. We recommend distributors keep a small stock of replacement service items on hand for convenience.





For more details of complete fixing packs, please see Standard Fixing Pack and Thick Door Kits Section.

Fixing Pack

Door Thickness	Function	Item Code	Price
1-3/8" to 1-3/4"	Fixing Pack for Smart Mortise Trim	FP-ISM	\$20
1-3/8" to 1-3/4"	Fixing Pack for Smart Mortise Trim Dummy	FP-ISM-DM	\$20
1-3/8" to 1-3/4"	Fixing Pack for Sectional ISM95 and Sectional ISM7000	FP-ISM02	\$20
1-3/8" to 1-3/4"	Fixing Pack for Sectional ISM95 and Sectional ISM7000 with Exterior Pull Handle	FP-ISM03	\$20
1-3/8" to 1-3/4"	Fixing Pack for Smart Deadbolt	FP-ISD01	\$20
1-3/8" to 1-3/4"	Fixing Pack for Smart Cylindrical Entry	FP-ISC01	\$20
1-3/8" to 1-3/4"	Fixing Pack for Tubular Interconnect Entry	FP-IST01	\$20
1-3/8" to 1-3/4"	Fixing Pack for Tubular Interconnect Entry with Sectional Keypad	FP-IST02	\$20

ADA Surface Pulls

Interior / Exterior Pull

Image	Length	CTC	Tube Dia.	Fixing	Item Code	Finish				
						32D	32	19G	PVD4 ¹ , 26D ¹	CeraMax ¹
						Price				
	8"	5"-1/2"	7/8"	Bolt-Thru	PHIX330.512.8 BT	\$98	\$108	\$113	\$113	\$228
	8-3/4"	8"	3/4"	Bolt-Thru	PHIX31108 BT	\$74	\$82	\$95	\$95	\$204
	8-3/4"	8"	3/4"	Bolt-Thru	PHIX30108 BT	\$79	\$85	\$98	N/A	\$209
	8-1/4"	7-1/4"	7/8"	Bolt-Thru	PHIX41714 BT	\$147	\$157	\$178	N/A	\$277
	7-3/4"	7-1/4"	7/8"	Bolt-Thru	PHIX45714 BT	\$147	\$157	\$178	N/A	\$277

¹ Finish Options

PVD4 finish available for PHIX330.512.8 and PHIX31108 Surface Pulls.





26D finish available for PHIX330.512.8 Surface Pull.

CeraMax Standard Finishes: C19G Graphite Black, C19 Flat Black, CGY Stormy Grey, CDB Dark Bronze, and CBB Burnt Bronze.

For PHIX fixing pack, see pages 36.

Surface Pulls

Interior / Exterior Pull



Image	Length	CTC	Tube Dia.	Fixing	Item Code	Finish		
						32D	32	CeraMax ¹
						Price		
U Style Pull 	6-3/4"	6"	3/4"	Bolt-Thru	PHIX31106 BT	\$73	\$82	\$203
	8-3/4"	8"	3/4"	Bolt-Thru	PHIX31108 BT	\$78	\$87	\$208
	10-3/4"	10"	3/4"	Bolt-Thru	PHIX31110 BT	\$64	\$69	\$214
	12-3/4"	12"	3/4"	Bolt-Thru	PHIX31112 BT	\$66	\$87	\$216
	16-3/4"	16"	3/4"	Bolt-Thru	PHIX311.16.1675 BT	\$92	N/A	\$242
	18-3/4"	18"	3/4"	Bolt-Thru	PHIX311.18.1875 BT	\$100	N/A	\$250
	11"	10"	1"	Bolt-Thru	PHIX31210 BT	\$74	\$79	\$224
	13"	12"	1"	Bolt-Thru	PHIX31212 BT	\$90	\$98	\$240
	13-1/4"	12"	1-1/4"	Bolt-Thru	PHIX31312 BT	\$116	\$129	\$266
	19-1/4"	18"	1-1/4"	Bolt-Thru	PHIX31318 BT	\$139	\$160	\$289
D Style Pull 	11"	10"	1"	Bolt-Thru	PHIX32210 BT	\$120	\$137	\$270
	13"	12"	1"	Bolt-Thru	PHIX32212 BT	\$129	\$144	\$279
	13-1/4"	12"	1-1/4"	Bolt-Thru	PHIX32312 BT	\$160	\$178	\$310
	19-1/4"	18"	1-1/4"	Bolt-Thru	PHIX32318 BT	\$196	\$217	\$346
L Style Pull 	8-3/4"	8"	3/4"	Bolt-Thru	PHIX301.8.875 BT	\$66	N/A	\$196
	16-3/4"	16"	3/4"	Bolt-Thru	PHIX301.16.1675 BT	\$101	N/A	\$251
	19-1/4"	18"	1-1/4"	Bolt-Thru	PHIX303.18.1925 BT	\$183	N/A	\$333
L2 Style Pull 	13"	12"	1"	Bolt-Thru	PHIX45012 BT	\$215	\$246	\$365

¹ Finish Options

CeraMax Standard Finishes: C19G Graphite Black, C19 Flat Black, CGY Stormy Grey, CDB Dark Bronze, and CBB Burnt Bronze.
For PHIX fixing pack, see pages 36.

Surface Pulls

Interior / Exterior Pull

Image	Length	CTC	Tube Dia.	Fixing	Item Code	Finish		
						32D	32	CeraMax ¹
						Price		
 90°	12"	9-1/2"	7/8"	Bolt-Thru	PHIX330.912.12 ST	\$147	N/A	\$297
	16"	13-1/2"	7/8"	Bolt-Thru	PHIX330.1312.16 ST	\$110	N/A	\$260
	18"	15-1/2"	7/8"	Bolt-Thru	PHIX330.1512.18 ST	\$110	N/A	\$260
	16"	13-1/4"	1-1/4"	Bolt-Thru	PHIX333.1325.16 ST	\$131	N/A	\$281
	18"	15-1/4"	1-1/4"	Bolt-Thru	PHIX333.1525.18 ST	\$144	N/A	\$294
 45°	18"	10"	1-1/4"	Bolt-Thru	PHIX34310 ST	\$163	\$178	\$313
	20"	12"	1-1/4"	Bolt-Thru	PHIX34312 ST	\$176	\$194	\$326
	26"	18"	1-1/4"	Bolt-Thru	PHIX34318 ST	\$222	\$241	\$372
 T2 Style Pull	Post for T-Shape Pulls				PHIX-PT45	\$43	\$47	

¹CeraMax Standard Finishes: C19G Graphite Black, C19 Flat Black, CGY Stormy Grey, CDB Dark Bronze, and CBB Burnt Bronze.

Fixing Packs (Bolt-Thru) for Surface Pulls

Surface Pull	Tube Dia.	Fixing	Door Thickness	Item Code	Finish	
					32,32D, 19G	CeraMax ¹
					Price	
PHIX301 PHIX311 PHIX41714 PHIX45714	3/4"	Bolt Thru	1-3/4"	PHIX9109	\$36	\$76
			2"			
			2-1/4"	PHIX9109 + PHIX9580	\$42	\$103
			2-1/2"			
			2-3/4"	PHIX9109 + PHIX9590	\$42	\$103
3"						
PHIX330 PHIX332	7/8" 1"	Bolt Thru	1-3/4"	PHIX9121	\$42	\$103
			2"	PHIX9121 + PHIX9680	\$48	\$108
			2-1/4"			
			2-1/2"	PHIX9121 + PHIX9690	\$48	\$108
			2-3/4"			
3"						
PHIX312 PHIX313 PHIX322 PHIX323 PHIX333 PHIX45012 PHIX343	1" 1-1/4" 1" 1-1/4" 1-1/4" 1" x 1/2" 1-1/4"	Bolt Thru	1-3/4"	PHIX9104	\$48	\$108
			2"			
			2-1/4"			
			2-1/2"	PHIX9104 - PHIX9138	\$54	\$113
			2-3/4"			
			3"			

¹CeraMax Standard Finishes: C19G Graphite Black, C19 Flat Black, CGY Stormy Grey, CDB Dark Bronze, and CBB Burnt Bronze.

LIST PRICES

Cylinders

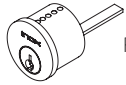

Rim Cylinder

Description	Cylinder Type	Size	Cylinder Code	Finish			
				32D	32 ³ ,19G	PVD4 ³	CeraMax ¹
Rim Cylinders Schlage C Keyway, 5 Pin with Tailpiece, 2 Keys Standard: Keyed Differently (KD)	Single	1"	CRB105	\$52	\$59	\$66	\$162
	Tubular Dummy	1"	CRA10D	\$52	\$59	\$66	\$162

³ Longer leadtimes and MOQ may apply, please check before ordering.

¹CeraMax Standard Finishes: C19G Graphite Black, C19 Flat Black, CGY Stormy Grey, CDB Dark Bronze, and CBB Burnt Bronze.



Mortise Cylinder

Description	Cylinder Type	Size	Cylinder Code	Finish			
				32D/26D ¹	32 ³ ,19G	PVD4 ³	CeraMax ¹
Mortise Cylinders Schlage C Keyway, 6 Pin with Clover L Cam, 2 Keys Standard: Keyed Differently (KD)	Mortise	15/16"	CMB0345	\$64	\$75	\$64	\$174
		1"	CMB105	\$64	\$75	\$64	\$174
		1-1/8"	CMB1186	\$70	\$82	\$70	\$180
		1-1/4"	CMB1146	\$70	\$82	\$70	\$180
		1-3/8"	CMB1386	\$76	\$88	\$76	\$186
		1-1/2"	CMB1126	\$76	\$88	\$76	\$186
		1-5/8"	CMB1586	\$82	\$94	\$82	\$192
		1-3/4"	CMB1346	\$82	\$94	\$82	\$192
	Mortise Dummy	1/2"	CMA10D	\$52	\$64	\$52	\$162

¹ 26D finish available for CMB1146

¹CeraMax Standard Finishes: C19G Graphite Black, C19 Flat Black, CGY Stormy Grey, CDB Dark Bronze, and CBB Burnt Bronze.

³ Longer leadtimes and MOQ may apply, please check before ordering.

Standard cylinder comes with Clover L Cam, for other Mortise Cams, use finish price plus \$10 upcharge

IC Core and Housing

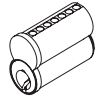

SFIC Core

Description	Cylinder Code	Finish		
		26D	19G	PVD4
IC Cylinder Core, 6 Pin, Best A Keyway Small Format, Combined	CMB-ICBA6-CMB⁴	\$92	\$106	\$92
IC Cylinder Core, 7 Pin, Best A Keyway Small Format, Combined	CMB-ICBA7-CMB	\$100	\$114	\$100
Construction Key available in 26D and also in RED and GRN painted faces, list desired finish when ordering				
IC Cylinder Core, 6 Pin, Best A Keyway Small Format, Construction Core <i>Two Keyed Alike (KA) and one Control Key, per Group of 10</i>	CMB-ICBA6-CST-FINISH	\$78	N/A	N/A
IC Cylinder Core, 7 Pin, Best A Keyway Small Format, Construction Core <i>Two Keyed Alike (KA) and one Control Key, per Group of 10</i>	CMB-ICBA7-CST-FINISH	\$85	N/A	N/A

⁴Black finish available on core - finish may not exactly match Black or Graphite Black finish







SFIC Housing

Description	Cylinder Code	Finish		
		26D, PVD4	19G	CeraMax
Mortise Cylinder ICBA Housing for 6 Pin, Less Core, 1-3/8"	CMB1386-ICBA-HUS	\$82	N/A	\$192
Mortise Cylinder SFIC Housing for 6 Pin, Less Core, 1-1/4"	CMB1146-ICBA-HUS	\$75	\$93	\$185
Mortise Cylinder SFIC Housing for 7 Pin, Less Core, 1-3/8"	CMB1387-ICBA-HUS	\$82	S/O	\$192
Mortise Cylinder LFIC Housing for 6 Pin, Less Core, 1-1/2"	CMB1126-LFIC-HUS	\$75	\$82	\$185
Mortise Cylinder SFIC Housing for 7 Pin, Less Core, 1-1/2"	CMB1127-ICBA-HUS	\$82	N/A	\$192

Cross Reference Chart for Cylinders and Collars by Trim

Item Code	Description	Trim	Collar Reference
CMB1126	1-1/2" Cylinder 6 Pin	XSF-MED	EC-R385COL Round Collar
CMB1186	1-1/8" Cylinder 6 Pin	SF / PD97	No Collar Required
		XSF-RIM	EC-R370COL Round Collar
CMB1146	1-1/4" Cylinder, 6 pin	ISM7000	No Collar Required
		XRA / XGT / ISMPD95	EC-R460COL Round Collar
		XSE / XGS	EC-S420COL Square Collar
		XSF-CVR	EC-R370COL Round Collar
CMB1386	1-3/8" Cylinder, 6 pin	TDKs	EC-R417COL Round Collar
			EC-S420COL + EC-R456COL Square Collar
CMB1126-ICBA-HUS	1-1/2" SFIC housing, 6 pin	XSF-MED	EC-R385COL Round Collar
CMB1386-ICBA-HUS	1-3/8" SFIC housing, 6 pin	SF / PD97	EC-R456COL Round Collar
CMB1146-ICBA-HUS	1-1/4" SFIC housing, 6 pin	XRA / XGT / ISMPD95	EC-R460COL Round Collar
		ISM7000	No Collar Required
		XSE / XGS	EC-S420COL Square Collar
		XSF-RIM / XSF-CVR	EC-R370COL Round Collar
CMB1387-ICBA-HUS	1-3/8" SFIC housing, 7 pin	XRA / XGT / ISMPD95	EC-R417COL Round Collar
		ISM7000	No Collar Required
		XSE / XGS	EC-S420COL + EC-R456COL Square Collar
		SF / PD97	EC-R456COL Round Collar
CMB1126-LFIC-HUS	1-1/2" LFIC housing, 6 pin	XSF-MED	EC-R385COL Round Collar
		XRA / XGT / ISMPD95	EC-R417COL Round Collar
		XSE XGS	EC-S420COL + EC-R456COL Square Collar
		SF / PD97 / ISM7000	EC-R456COL Round Collar
		XSF-RIM / XSF-CVR	EC-R370COL Round Collar
CMB1127-ICBA-HUS	1-1/2" SFIC housing, 7 pin	XSF-RIM / XSF-CVR	EC-R370COL Round Collar
		XSF-MED	EC-R385COL Round Collar

Collars

			Finish				
			32D	32	10B	19G	CeraMax
Illustration	Function	Item Code	Price				
	Round Extended Collar for XRA/XGT 1-3/8 – 1-1/2" IC Mortise Cylinder	EC-R417COL	\$22	\$28	N/A	\$34	\$92
	Round Collar for LA/SF Entry or RA/GT Mortise Cylinder 1-1/4" Cylinder	EC-R460COL	\$16	\$22	\$24	N/A	\$86
	Square Collar for LA/SF Entry or SE/GS Mortise Cylinder 1-1/4" Cylinder	EC-S420COL ⁵	\$22	\$28	\$34	N/A	\$92
	Round Collar for XSF Trim 1-1/8 – 1-1/2" Mortise Cylinder	EC-R370COL	\$28	\$34	N/A	N/A	\$98
	Universal Round Collar	EC-R456COL ⁵	\$34	\$40	N/A	\$42	\$104

⁵ EC-R456COL must be paired with EC-S420COL when using Square XSE/XGS style Trim with 1-3/8 – 1-1/2" IC Cylinders. EC-R456COL can be used as a stand alone collar when using Round XRA/XGT style Trim with 1-3/8 – 1-1/2" IC Cylinders.

Keying Service Options

Service Code	Description	Price
SV-KYCT	Service: Key Cut including Key Blank	\$12 Per Key
SV-KA	Service: Keyed Alike (KA) - Each cylinder in the group is keyed alike 2 Keys per KA Group of 10 included	\$18 Per Cylinder
SV-KASN	Service: Keyed Alike Group (Specify Number of Keyed Alike Per Group) Each cylinder in the group is keyed alike 2 Keys per KA Group of 10 included	\$18 Per Cylinder
SV-KS	Service: Keyed to Specific Code - Cylinder is keyed to a specific code 2 keys per KS Group of 10 included	\$18 Per Cylinder
SV-MK	Service: Master Keying - 2 Change Keys per Cylinder and 3 Master Keys per MK Group of 10 included (CMK ordered separately if required)	\$28 Per Cylinder
SV-GMK	Service: Grand Master Keying (2 or more MK groups included), 2 Change Keys per Cylinder, 3 Grand Master Keys per GMK Group & 3 Master Keys per MK Group of 10 included. (CMK ordered separately if required)	\$32 Per Cylinder

All standard cylinders are keyed different for standard order.

Service Code	Description	Price
SV-ICKYCT	Service: IC Core Key Cut including Key Blank	\$23 Per Key
SV-ICKA	Service: IC Core Keyed Alike (KA) - Each cylinder in the group is keyed alike 2 Keys per KA Group of 10 included	\$32 Per Core
SV-ICKS	Service: IC Core Keyed to Specific Code - Cylinder is keyed to a specific code 2 keys per KS Group of 10 included	\$32 Per Core
SV-ICMK	Service: IC Core Master Keying - 2 Change Keys per Cylinder and 3 Master Keys per MK Group of 10 included (CMK ordered separately if required)	\$52 Per Core
SV-ICGMK	Service: IC Core Grand Master Keying (2 or more MK groups included), 2 Change Keys per Cylinder, 3 Grand Master Keys per GMK Group & 3 Master Keys per MK Group of 10 included. (CMK ordered separately if required)	\$58 Per Core

All IC Core are keyed different for standard order.

Service Code	Description	Price
SV-CYKYCT	Service: Euro Cylinder Key Cut including Key Blank	\$23 Per Key
SV-CYKA	Service: Euro Cylinder Keyed Alike (KA) - Each cylinder in the group is keyed alike 2 Keys per KA Group of 10 included	\$32 Per Cylinder
SV-CYKS	Service: Euro Cylinder Keyed to Specific Code - Cylinder is keyed to a specific code 2 keys per KS Group of 10 included	\$32 Per Cylinder
SV-CYMK	Service: Euro Cylinder Master Keying - 2 Change Keys per Cylinder and 3 Master Keys per MK Group of 10 included (CMK ordered separately if required)	\$52 Per Cylinder
SV-CYGMK	Service: Euro Cylinder Grand Master Keying (2 or more MK groups included), 2 Change Keys per Cylinder, 3 Grand Master Keys per GMK Group & 3 Master Keys per MK Group of 10 included (CMK ordered separately if required)	\$58 Per Cylinder

All Euro cylinders are keyed different for standard order.

Euro Profile Cylinders and Half Cylinders

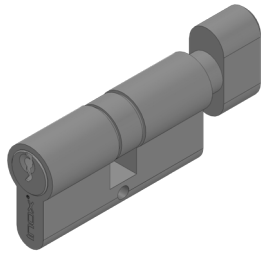
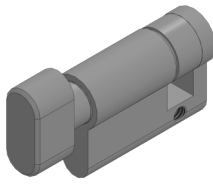
Cylinders	Size Overall (L)	Size Split (A/B)	Item Code	Finish		
				15	10B, 26, 19G, 4	CGY, CDB, C19G, C19
				Price		
 <p>Euro Profile Cylinders Keyed and Thumbturn Schlage C Keyway, 5 Pin 3 Keys M5x80 Breakable Screw</p>	70mm	35/35mm	CYEU-3535TK	\$76	\$91	\$236
	80mm	40/40mm	CYEU-4040TK	\$76	\$91	\$236
	85mm	35/50mm 50/35mm 30/55mm 55/30mm	CYEU-3550TK CYEU-5035TK CYEU-3055TK CYEU-5530TK	\$76	\$91	\$236
	90mm	45/45mm	CYEU-4545TK	\$76	\$91	\$236
	100mm	50/50mm	CYEU-5050TK	\$76	\$91	\$236
 <p>Euro Profile Half Cylinders Thumbturn only M5x80 Breakable Screw</p>	45mm	10/35mm	CYEU-1035TK	\$76	\$91	\$236
	50mm	10/40mm	CYEU-1040TK	\$76	\$91	\$236
	55mm	10/45mm	CYEU-1045TK	\$76	\$91	\$236
	60mm	10/50mm	CYEU-1050TK	\$76	\$91	\$236
	65mm	10/55mm	CYEU-1055TK	\$76	\$91	\$236

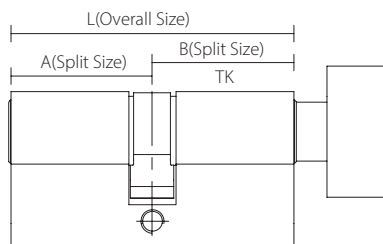
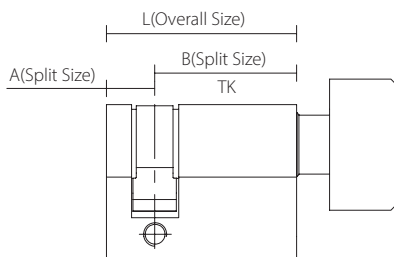

Concealed Bearing Hinges
HEAVY WEIGHT, 3 KNUCKLE BEARING

						Finish	
Stainless Steel						32D	32
Size	Corner	Thickness (Ga.)	Type	QTY	Item No.	Price (EA)	
4-1/2" x 4-1/2"	Square Corner	0.180" (4.6mm)	Concealed Bearing	EA	HG5111CB-47	\$98	S/O
5" x 4-1/2"	Square Corner	0.190" (4.8mm)	Concealed Bearing NRP	EA	HG5111CB-NRP-56	\$106	S/O

						Finish		
Steel						26D	10B	19G
Size	Corner	Thickness (Ga.)	Type	QTY	Item No.	Price (EA)		
4-1/2" x 4-1/2"	Square Corner	0.180" (4.6mm)	Concealed Bearing	EA	HG8111CB-47	S/O	\$40	S/O
			Concealed Bearing NRP	EA	HG8111CB-NRP-47	\$56	S/O	S/O
5" x 4-1/2"	Square Corner	0.190" (4.8mm)	Concealed Bearing	EA	HG8111CB-56	\$59	\$59	S/O
			Concealed Bearing NRP	EA	HG8111CB-NRP-56	\$62	\$62	S/O

						Finish		
STANDARD WEIGHT, 3 KNUCKLE BEARING						26D	10B	19G
Steel								
Size	Corner	Thickness (Ga.)	Type	QTY	Item No.	Price (EA)		
4-1/2" x 4-1/2"	Square Corner	0.134" (3.4mm)	Concealed Bearing	EA	HG8112CB-45	\$33	\$35	\$40
			Concealed Bearing NRP	EA	HG8112CB-NRP-45	\$38	S/O	S/O
		0.180" (4.6mm)	Concealed Bearing NRP	EA	HG8112CB-NRP-47	S/O	\$40	S/O
5" x 4-1/2"	Square Corner	0.146" (3.7mm)	Concealed Bearing	EA	HG8112CB-54	\$40	S/O	S/O
			Concealed Bearing NRP	EA	HG8112CB-NRP-54	\$46	S/O	S/O

NRP: Non-removable Pin
 CB: Concealed Bearings
 S/O: Special order item, contact the sales department for pricing and lead times.

Template Hinges

Standard weight, 2 Anti-friction ball bearing & plain bearing

						Finish	
Stainless Steel						32D	32
Size	Corner	Thickness (Ga.)	Type	QTY	Item No.	Price (EA)	
4" x 4"	Square Corner	0.13" (3.3mm)	2 Ball Bearing	EA	HG5112-43	\$61	\$71
			2 Ball Bearing NRP	EA	HG5112NRP-43	\$65	S/O
	1/4" Radius Corner	0.13" (3.3mm)	2 Ball Bearing NRP	EA	HG5112R14NRP-43	\$62	\$66
	5/8" Radius Corner	0.13" (3.3mm)	2 Ball Bearing NRP	EA	HG5112R58NRP-43	\$62	\$66
4-1/2" x 4"	Square Corner	0.134" (3.4mm)	2 Ball Bearing	EA	HG5112-44	\$64	S/O
4-1/2" x 4-1/2"	Square Corner	0.134" (3.4mm)	2 Ball Bearing	EA	HG5112-45	\$66	S/O
			2 Ball Bearing NRP	EA	HG5112NRP-45	\$70	S/O

						Finish		
Steel						15 ⁶ , 4 ⁶ , 26D	19G 10B	26
Size	Corner	Thickness (Ga.)	Type	QTY	Item No.	Price (EA)		
4" x 4"	Square Corner	0.134" (3.4mm)	2 Ball Bearing	EA	HG8112-43	\$25	\$29	S/O
	Radius Corner		2 Ball Bearing	EA	HG8112R14-43	\$25	S/O	S/O
4-1/2" x 4"	Square Corner	0.134" (3.4mm)	2 Ball Bearing	EA	HG8112-44	\$25	S/O	S/O
			2 Ball Bearing NRP	EA	HG8112NRP-44	\$27	S/O	S/O
4-1/2" x 4-1/2"	Square Corner	0.134" (3.4mm)	2 Ball Bearing	EA	HG8112-45	\$26	\$29	\$33
			2 Ball Bearing NRP	EA	HG8112NRP-45	\$29	\$33	S/O
5" x 4-1/2"	Square Corner	0.146" (3.7mm)	2 Ball Bearing	EA	HG8112-54	\$33	S/O	S/O
			2 Ball Bearing NRP	EA	HG8112NRP-54	\$36	S/O	S/O

⁶Finish Options

15 finish available for HG8112-45

4 finish available for HG8112-45

NRP: Non-removable Pin

S/O: Special order item, contact the sales department for pricing and lead times.

Spring Hinges
COMMERCIAL WEIGHT

						Finish	
Stainless Steel						32D	32
Size	Corner	Thickness (Ga.)	Type	QTY	Item No.	Price (EA)	
4" x 4"	Square Corner	0.13" (3.3mm)	Spring Hinges	EA	HG5107SP-43	\$86	S/O
	Radius Corner		Spring Hinges	EA	HG5107SPR14-43	\$86	S/O
4-1/2" x 4-1/2"	Square Corner	0.134" (3.4mm)	Spring Hinges	EA	HG5107SP-45	\$92	S/O

						Finish	
Steel						26D	19G, 10B
Size	Corner	Thickness (Ga.)	Type	QTY	Item No.	Price (EA)	
4" x 4"	Radius Corner	0.13" (3.3mm)	Spring Hinges	EA	HG8107SPR14-43	\$40	S/O
4-1/2 x 4-1/2"	Square Corner	0.134" (3.4mm)	Spring Hinges	EA	HG8107SP-45	\$42	\$46

Heavy Duty Template Hinges

HEAVY WEIGHT, 4 ANTI-FRICTION BALL BEARING

						Finish	
Stainless Steel						32D	32
Size	Corner	Thickness (Ga.)	Type	QTY	Item No.	Price (EA)	
4-1/2" x 4-1/2"	Square Corner	0.180" (4.6mm)	4 Ball Bearing	EA	HG5111-47	\$92	S/O
			4 Ball Bearing NRP	EA	HG5111NRP-47	\$96	S/O
5" x 4-1/2"	Square Corner	0.190" (4.8mm)	4 Ball Bearing	EA	HG5111-56	\$98	S/O
5" X 5"	Square Corner	0.190" (4.8mm)	4 Ball Bearing	EA	HG5111-57	\$103	S/O

						Finish	
Steel						26D	10B, 19G
Size	Corner	Thickness (Ga.)	Type	QTY	Item No.	Price (EA)	
4-1/2" x 4-1/2"	Square Corner	0.180" (4.6mm)	4 Ball Bearing	EA	HG8111-47	\$46	S/O
			4 Ball Bearing NRP	EA	HG8111NRP-47	\$51	S/O
5" x 4-1/2"	Square Corner	0.190" (4.8mm)	4 Ball Bearing	EA	HG8111-56	\$53	S/O
			4 Ball Bearing NRP	EA	HG8111NRP-56	\$57	S/O
5" x 5"	Square Corner	0.190" (4.8mm)	4 Ball Bearing	EA	HG8111-57	\$55	S/O
			4 Ball Bearing NRP	EA	HG8111NRP-57	\$59	S/O

Power Transfer Hinges

						Finish	
Steel						26D	19G
Size	Corner	Thickness (Ga.)	Type	QTY	Item No.	Price (EA)	
4-1/2" x 4-1/2"	Square Corner	0.134" (3.4mm)	2 Ball Bearing	EA	HG8112-45-ETH4W	\$408	\$438

NRP: Non-removable Pin

S/O: Special order item, contact the sales department for pricing and lead times.

Residential Hinges
PLAIN BEARING HINGES

						Finish	
Stainless Steel						32D	32
Size	Corner	Thickness (Ga.)	Type	QTY	Item No.	Price (EA)	
4" x 4"	Square Corner	0.13" (3.3mm)	Plain Bearing	EA	HG5133-43	\$50	S/O

						Finish	
Steel						26D	19G
Size	Corner	Thickness (Ga.)	Type	QTY	Item No.	Price (EA)	
4-1/2" x 4-1/2"	Square Corner	0.134" (3.4mm)	Plain Bearing	EA	HG8133-45	\$22	S/O

S/O: Special order item, contact the sales department for pricing and lead times.

Residential Hinges
COMMERCIAL WEIGHT

						Finish	
Stainless Steel						32D	32
Size	Corner	Thickness (Ga.)	Type	QTY	Item No.	Price (EA)	
4" x 4"	Square Corner	0.097" (2.5mm)	Hinges	EA	HG5184-42	\$40	\$45
	Radius 1/4" Corner			EA	HG5184R14-42	\$40	\$45
	Radius 5/8" Corner			EA	HG5184R58-42	\$40	\$45

NRP: Non-removable Pin

S/O: Special order item, contact the sales department for pricing and lead times.









Stainless Steel Door Stops

For Interior Doors

Image	Description	Item No.	Finish				
			32D	32	10B, 19G	PVD4	CGY, CDB C19G, C19
			Price				
	Floor mounted Screws included	DSIX02	\$30	\$32	\$32	\$32	\$90
	Wall mounted, also can be used as coat hook, screws included	DSIX04	\$27	\$33	\$33	\$33	\$87
	Black rubber tip only	DSIX04RUB	\$7	N/A	N/A	N/A	N/A
	Floor or wall mounted Screws included	DSIX05	\$22	\$24	N/A	N/A	\$82
	Floor mounted Screws included	DSIX06	\$25	\$27	N/A	N/A	\$85
	Wall mounted Screws included	DSIX07	\$25	\$27	N/A	N/A	\$85
	Wall mounted Screws included	DSIX08	\$23	\$25	N/A	\$25	\$83
	Wall mounted, screws included	DSIX09	\$22	\$24	\$24	\$24	\$82
	Door Stop Extension	DSIX09EX	\$17	\$19	\$19	N/A	\$77
	Black rubber tip only	DSIX09RUB	\$7	N/A	N/A	N/A	N/A
	White rubber tip only	DSIX09RUB-WH	\$10	N/A	N/A	N/A	N/A
	Wall mounted, also can be used as coat hook, screws included	DSIX14	\$23	\$25	\$25	\$25	\$83
	Black rubber tip only	DSIX14RUB	\$7	N/A	N/A	N/A	N/A
	Wall mounted, also can be used as coat hook, screws included	DSIX19	\$25	\$27	\$27	\$27	\$85
	Black rubber tip only	DSIX14RUB	\$7	N/A	N/A	N/A	N/A
	Floor mounted Screw included	DSIX26	\$46	\$50	\$50	\$50	\$106
	Floor mounted Screw included	DSIX34	\$43	\$46	\$46	\$46	\$103

Stainless Steel Pocket Pulls

For Interior Doors

Image	Description	Item No.	Finish			
			32, 32D	19G	PVD4	CGY, CDB C19G, C19
			Price			
	Pocket pull circular faceplate dia. 2-9/16", concealed fixing, screws included	FHIX01	\$22	\$24	\$24	\$112
	Pocket pull semi-circular faceplate dia. 3-9/16", concealed fixing, screws included	FHIX02	\$30	N/A	\$25	\$120
	Pocket pull rectangular faceplate 2-3/8"x7-1/16", concealed fixing, screws included	FHIX03	\$33	\$37	\$37	\$123
	Pocket pull oblong faceplate 1-5/8"x4-3/4", concealed fixing, screws included	FHIX04	\$22	\$24	\$24	\$112
	Pocket pull square faceplate 2-3/4", concealed fixing, screws included	FHIX05	\$30	\$35	\$35	\$120
	Pocket pull rectangular faceplate 1-7/8" x 4-3/4", concealed fixing, screws included	FHIX06	\$22	\$24	\$24	\$112
	Pocket pull rectangular faceplate 2-3/8"x7-1/16", with rectangular opening, concealed fixing, screws included	FHIX07	\$33	\$37	\$37	\$123
	Round edge pull, 1" (25.4mm) dia., concealed fixing, screws included	EPIX01	\$14	\$17	\$17	\$104

CeraMax™ Price Groups

Group A				Group B										Group C	
Graphite Black C19G	Stormy Grey CGY	Flat Black C19	Dark Bronze CDB	Aqua Blue C26	Goblin Green C23	Red Hot C28	Bordeaux C20	Pink Bubblegum C22	Purple Reign C25	Deep Blue Sea C27	Ocean Blue C24	Cobalt Cool C31	Sand Man C29	Moon Light C30	Sun Dazed C21

Custom Items

Please note that custom requests require special pricing and may not be covered under our warranty. Contact sales@unisonhardware.com for more information.

CeraMax™ Finishes

CeraMax™ ceramic coating finishes are guaranteed against finish defects and cracking, chipping, peeling, and flaking under normal use for up to two (2) years for commercial interior use. Ceramic coating will wear over time under normal use, and this warranty does not cover normal wear and tear of the product (which varies per color of finish) or any damage, alteration, or abuse to the finish from neglect or accident. Exterior installation or exposure to UV light will affect ceramic coating as part of normal wear and tear. INOX CeraMax ceramic coating is not UV rated. Contact INOX for information on higher UV CeraMax protection if needed.

Not covered under this Warranty:

- Product that has been scratched or abraded
- Product that has been incorrectly installed or mistreated
- Product installed in exterior applications and/or exposed to the water, outdoor weather, or elements, harsh environments, and/or commercial or industrial applications.
- Living Finishes, which are specifically designed to wear over time (i.e., Oil Rubbed Bronze finish)

UNISON HARDWARE, INC. MAKES NO OTHER WARRANTY, AND ALL IMPLIED WARRANTIES INCLUDING ANY WARRANTY OF MERCHANTABILITY OR FITNESS FOR A PARTICULAR PURPOSE ARE LIMITED TO THE DURATION OF THE EXPRESSED WARRANTY PERIOD AS SET FORTH ABOVE. THE COMPANY'S MAXIMUM LIABILITY HEREUNDER IS LIMITED TO THE PURCHASE PRICE OF THE PRODUCT. IN NO EVENT SHALL THE COMPANY BE LIABLE FOR ANY CONSEQUENTIAL, INDIRECT, INCIDENTAL OR SPECIAL DAMAGES OF ANY NATURE ARISING FROM THE SALE OR USE OF THIS PRODUCT, WHETHER IN CONTRACT, TORT, STRICT LIABILITY OR OTHERWISE. THIS LIMITED WARRANTY IS IN LIEU OF ALL OTHER WARRANTIES, EXPRESSED OR IMPLIED, INCLUDING THE IMPLIED WARRANTIES OF FITNESS AND MERCHANTABILITY. THERE ARE NO WARRANTIES WHICH EXTEND BEYOND THE DESCRIPTION ON THE FACE HEREOF.

CeraMax™ Price Groups

To order INOX Ceramic Coating:

1. Select from the product category below the upcharge list price to be applied to the 32D list price.h
2. Select the group [A or B or C] finish and add upcharge list pricing in chart
3. Additional one time setup fee per color based on quantities for Rainbeaux™ Group B & C
 - \$450 NET for quantities less than and equal to 25 pieces / sets
 - \$300 NET for quantities greater than 25 pieces / sets

Lead Times:

- 4 - 5 weeks for Group A
- 6 - 8 weeks for Group B & C

Category	Series or Size	Group A	Group B	Group C
Smart Locks	ISTH Full Plate Handleset Keypad	\$400	\$500	\$800
	ISM Full Plate Reader / Keypad with Trim (MC7000 / PD9500)	\$380	\$480	\$680
	ISM Sectional Reader / Keypad with Trim (MC7000 / PD9500)	\$340	\$440	\$640
	IST Full Plate Keypad with Trim	\$380	\$480	\$680
	IST Sectional Keypad with Trim	\$340	\$440	\$640
	ISD with Trim and ISC	\$340	\$440	\$640
	ISD without Trim	\$300	\$300	\$600
Entrance Handlesets	NY / MH / ME / BW - Tubular Active / Dummy Sets	\$480	\$540	\$960
	NY / MH / ME / BW - Mortise Active / Dummy Sets	\$430	\$490	\$860
Exit Device Trim	XSF Entry / Night Latch	\$190	\$240	\$380
	XSF Passage / Dummy	\$170	\$220	\$340
Lock Sets	XRA / XSE / XGT / XGS Series	\$190	\$220	\$380
	SF / LA Tubular & Mortise	\$280	\$330	\$560
	SF / LA Tubular & Mortise Dummy Pair	\$200	\$230	\$400
Interior	RA / SE / GT / GA / GS / SH Tubular Latch Sets	\$180	\$210	\$280
	RA / SE / GT / GA / GS / SH Tubular Half Sets	\$150	\$170	\$300
	RA / SE / GT / GA / GS / SH Tubular Single Dummy	\$120	\$140	\$240
Cylindrical Locks	BL / BM / BK / CL / CK - 07 or 09 lever Set	\$240	\$280	\$480
	BL / BM / BK / CL / CK - 07 or 09 Single Dummy	\$190	\$220	\$380
Universal Multipoint	BP / MU - All lever designs & functions	\$230	\$310	\$460
Deadbolts / Privacy Bolts	All series	\$180	\$190	\$360
PD2000	Complete sets with Flush Pulls FH12 / FH13 / FH22CF / FH23CF	\$190	\$210	\$380
Pocket Door Locks PD8000 / PD5000	Complete sets with Flush Pulls FH17 / FH22 / FH23 / FH27 / FH29 / FH31 / FH32	\$250	\$300	\$500
	Complete set the ADA Pull PHIX31108 / PHIX30108 / PHIX330.512.8	\$280	\$330	\$560
	Flush Pulls Only FH17/ FH22 / FH23 / FH27 / FH29 / FH31 / FH32	\$120	\$130	\$240
Sliding Door Locks PD9000 Series	Complete Sets	\$280	\$460	\$560
Surface Pulls <i>Pricing is per single pull (BT) For BTB pricing will be multiplied by 2</i>	8" ADA Pulls	\$130	\$160	\$260
	Over 8" to 18" CTC Pull	\$150	\$180	\$300
	Over 18" to 33" CTC Pull	\$280	\$310	\$560
	Over 33" to 48" CTC Pull	\$430	\$490	\$860
	Over 48" to 60" CTC Pull	\$580	\$660	\$1,160
Barn Door Locks	BD1000 & BD4000	\$130	\$160	\$260
Accessories	Rim and Mortise Cylinder, IC Core Housing	\$120	\$130	\$220
	Euro Cylinder	\$160	\$190	\$320
	Faceplate only	\$60	\$70	\$120
	Strike only	\$40	\$50	\$80
	Thumbturn only	\$70	\$81	\$140
	Hinges - Plain Bearing	\$400	\$460	\$800
	Thick Door Kits (Privacy / Handlesets)	\$120	\$130	\$240
	Doorstops - DSIX	\$60	\$70	\$120
	Flush Pulls / Edge Pulls - FHIX / EPIX	\$90	\$130	\$180
	Letters - LTIX / Numbers - NUIX	\$70	\$80	\$140

Special Order PVD Upcharge Pricing

To order INOX Special Order PVDs:

1. Select from the product category below the upcharge list price to be applied to the 32D list price.
2. The combination of the 32D list price plus the upcharge list price, customer discount is then applied.
3. Special order items have a leadtime of 10 - 12 weeks from the date order is received.

Category	Series or Size	List Price
Smart Locks	ISTH Full Plate Handleset Keypad	\$750
	ISM Full Plate Reader / Keypad with Trim (MC7000 / PD9500)	\$475
	ISM Sectional Reader / Keypad with Trim (MC7000 / PD9500)	\$475
	IST Full Plate Keypad with Trim	\$475
	IST Sectional Keypad with Trim	\$425
	ISD with Trim and ISC	\$375
Entrance Handlesets	NY / MH / ME / BW - Tubular Active / Dummy Sets	\$750
	NY / MH / ME / BW - Mortise Active / Dummy Sets	\$750
Exit Device Trim	XSF Entry / Night Latch	\$475
	XSF Passage / Dummy	\$400
Lock Sets	XRA / XSE / XGT / XGS Series	\$350
	SF / LA Tubular & Mortise	\$475
	SF / LA Tubular & Mortise Dummy Pair	\$400
Interior	RA / SE / GT / GA / GS / SH Tubular Latch Sets	\$325
	RA / SE / GT / GA / GS / SH Tubular Half Sets	\$275
	RA / SE / GT / GA / GS / SH Tubular Single Dummy	\$175
Cylindrical Locks	BL / BM / BK / CL / CK - 07 or 09 lever Set	\$325
	BL / BM / BK / CL / CK - 07 or 09 Single Dummy	\$275
Universal Multipoint	BP / MU - All lever designs & functions	\$375
Deadbolts / Privacy Bolts	All series	\$375
PD2000	Complete sets with Flush Pulls FH12 / FH13 / FH22CF / FH23CF	\$275
Pocket Door Locks PD8000 / PD5000	Complete sets with Flush Pulls FH17 / FH22 / FH23 / FH27 / FH29 / FH31 / FH32	\$325
	Complete set the ADA Pull PHIX31108 / PHIX30108 / PHIX330.512.8	\$375
	Flush Pulls Only FH17 / FH22 / FH23 / FH27 / FH29 / FH31 / FH32	\$225
Sliding Door Locks PD9000 Series	Complete Sets	\$350
Surface Pulls <i>Pricing is per single pull (BT)</i> <i>For BTB pricing will be multiplied by 2</i>	8" ADA Pulls	\$225
	Over 8" to 18" CTC Pull	\$225
	Over 18" to 33" CTC Pull	\$350
	Over 33" to 48" CTC Pull	\$550
	Over 48" to 60" CTC Pull	\$700
Barn Door Locks	BD1000 & BD4000	\$225
Accessories	Rim and Mortise Cylinder, IC Core Housing	\$150
	Euro Cylinder	\$225
	Faceplate only	\$60
	Strike only	\$40
	Thumbturn only	\$70
	Hinges - Plain Bearing	\$525
	Thick Door Kits (Privacy / Handlesets)	\$125
	Doorstops - DSIX	\$100
	Flush Pulls / Edge Pulls - FHIX / EPIX	\$150
	Letters - LTIX / Numbers - NUIX	\$100

MicroArmor™ Price

To order INOX MicroArmor Antimicrobial Coating:

1. Take list of desired product with requested finish

2. Add upcharge list pricing in chart

3. Calculate your company's discount price

Setup Fee:

Clear Coat \$80 NET

Black Coat: \$450 NET

Lead Times:

2 - 4 weeks for Group A

2 - 6 weeks for Group B

Category	Series or Size	Clear Coat	Black Coat
		Add to List Price	
Interiors	RA / SE / GT / GS / SH Tubular Latch Sets	\$180	\$280
	RA / SE / GT / GS / SH Tubular Half Passage	\$150	\$300
	RA / SE / GT / GS / SH Tubular Single Dummy	\$120	\$240
Lock Sets	XRA / XSE / XGT / XGS Series	\$190	\$380
	SF / LA Tubular & Mortise	\$280	\$560
	SF / LA Tubular & Mortise Dummy Pair	\$200	\$400
Cylindrical Locks	BL / BM / BK / CL / CK - 07 or 09 lever Set	\$240	\$480
	BL / BM / BK / CL / CK - 07 or 09 Single Dummy	\$190	\$380
Entrance Handleset	NY / MH / ME / BW - Tubular Active / Dummy Sets	\$480	\$960
	NY / MH / ME / BW - Mortise Active / Dummy Sets	\$430	\$860
Universal Multipoint	BP / MU - All lever designs & functions	\$230	\$460
Deadbolts / Privacy Bolts	All series	\$180	\$360
PD2000	Complete sets with Flush Pulls FH12 / FH13 / FH22CF / FH23CF	\$190	\$380
Pocket Door Locks PD8000 / PD5000	Complete sets with Flush Pulls FH17 / FH22 / FH23 / FH27 / FH29 / FH31 / FH32	\$250	\$500
	Complete set the ADA Pull PHIX31108 / PHIX30108 / PHIX330.512.8	\$280	\$560
	Faceplate only	\$60	\$120
	Strike only	\$40	\$80
	Thumbturn only	\$70	\$140
	Flush Pulls Only FH17 / FH22 / FH23 / FH27 / FH29 / FH31 / FH32	\$120	\$240
Sliding Door Locks PD9000 Series	Complete Sets	\$280	\$560
Surface Pulls <i>Pricing is per single pull (BT) For BTB pricing will be multiplied by 2</i>	8" ADA Pulls	\$130	\$260
	Over 8" to 18" CTC Pull	\$150	\$300
	Over 18" to 33" CTC Pull	\$280	\$560
	Over 33" to 48" CTC Pull	\$430	\$860
	Over 48" to 60" CTC Pull	\$580	\$1,160
	Greater than 60" CTC Pull	\$690	\$1,380
Barn Door Locks	BD1000 & BD4000	\$130	\$260
Accessories	Rim and Mortise Cylinder, IC Core Housing	\$120	\$220
	Euro Cylinder	\$160	\$320
	Hinges - Plain Bearing	\$400	\$800
	Thick Door Kits (Privacy / Handlesets)	\$120	\$240
	Doorstops - DSIX	\$60	\$120
	Flush Pulls / Edge Pulls - FHIX / EPIX	\$90	\$180
	Letters - LTIX / Numbers - NUIX	\$70	\$140
Exit Device Trim	XSF Entry / Night Latch	\$190	\$380
	XSF Passage / Dummy	\$170	\$340

Understanding Handing

Swing Door versus Sliding Door

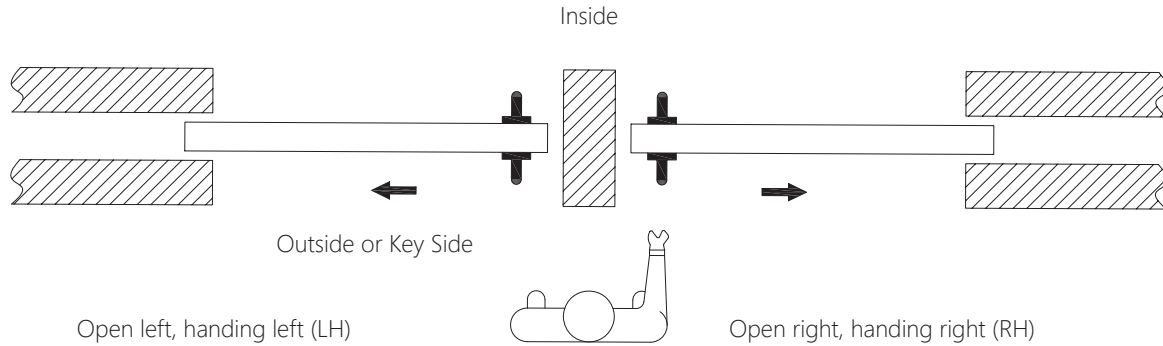

SLIDING DOOR HANDING

- Handing refers to the direction the door slides open. Example: If the door slides to the left to open, it is a left-handed door.
- Determine door direction from the exterior or key side of the door when facing into the room.

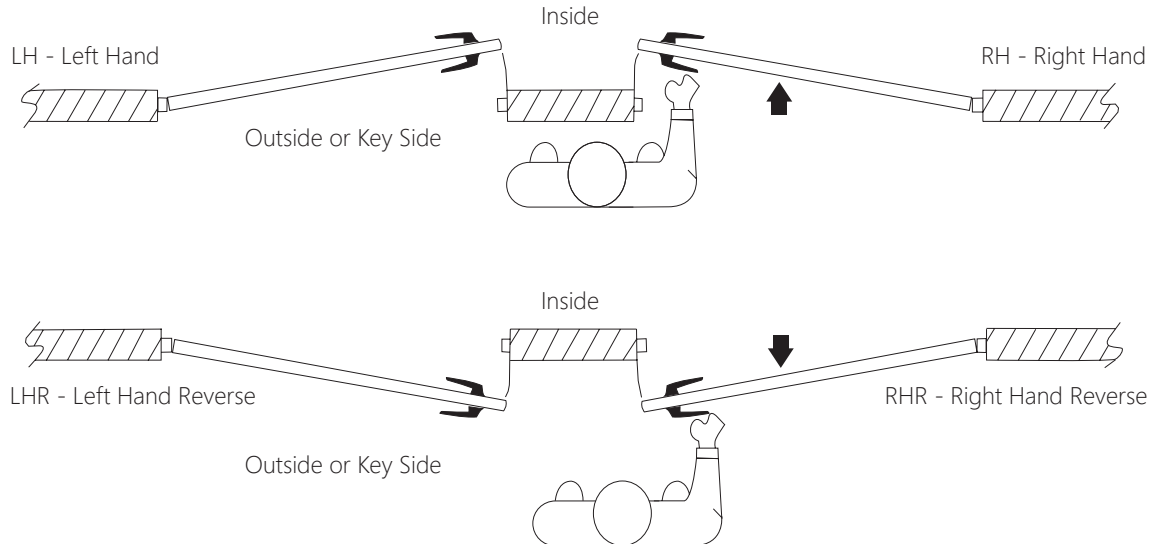

SWING DOOR HANDING

- Handing refers to the direction the door swings open. Example: If the door swings open to the left, it is a left-handed door.
- Determine door direction from the exterior or key side of the door when facing into the room.

Marketing items available from INOX



INOX Swatch Book
MKT-SWBK-2019.1



INOX 24 Swatch Ring
MKT-SWRG-24SW



INOX CeraMax Rainbeaux Swatch Ring
MKT-SWRG-RBSW



INOX Stacked Swatches
MKT-SWRG-STSW



INOX Gen 6 Tower
MKT-TWR-G6

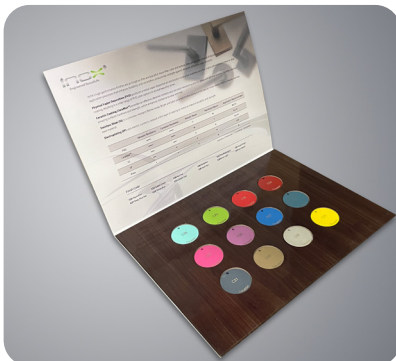

INOX Rainbeaux Swatch Book
MKT-SWBK-RAINBEAUX

INOX RESIDENTIAL PRODUCT WARRANTY

Limited Mechanical Warranty

Unison Hardware, Inc. ("INOX") warrants its residential products shall be free from defects in material and workmanship under normal use and regular service and maintenance for the life of the product for Residential use, excluding components made of wood, leather, or plastic. This Warranty extends to the original purchaser and first consumer owner only.

If a product fails due to defects in material or workmanship during the warranty period, INOX will replace it with the most nearly identical product which we sell at the time. INOX will not be liable for any labor charges or freight costs incurred in connection with repair or replacement of a product. Our sole and maximum liability for defective goods (sold and manufactured by INOX) shall never exceed the cost of the subject products.

This warranty does not cover:

1. Damage resulting from negligence, misuse, abuse, or accident occurring during or after installation
2. Damage due to use outside normal architectural requirements
3. Defects resulting from any modification or improper installation
4. Improper torquing (tightening) during or after installation
5. Improper door preparation
6. Use of residential grade products in commercial applications
7. Products installed in exterior application and/or exposed to the water, outdoor weather, or elements

Custom Items

Custom Items require special pricing and may not be covered under our warranty. Contact sales@unisonhardware.com for more information.

Finishes

With regular care and maintenance to remove stains, dirt, and condensation, Finishes are also covered for a period of three (3) years.

This warranty does not cover:

1. Damage resulting from using installation compounds that are harmful to brass and metal finishes or using improper cleaning solutions such as disinfection/antibacterial solutions or any cleaning detergent containing chlorides, alcohol or lime deposits
2. Product installed in exterior applications and/or exposed to the water, outdoor weather, or elements, harsh environments, and/or commercial or industrial applications
3. Changes to finish that normally take place with the passage of time
4. Use in any manner contrary to INOX's printed instructions.

CeraMax™ Finishes

CeraMax ceramic coating finishes are guaranteed against finish defects and cracking, chipping, peeling, and flaking under normal use for up to two years for commercial use. Ceramic coating will wear over time under normal use, and this warranty does not cover normal wear and tear of the product (which varies per color of finish) or any damage, alteration, or abuse to the finish from neglect or accident. Exterior installation, exposure to UV light or salt spray will affect ceramic coating as part of normal wear and tear. INOX CeraMax ceramic coating is not UV rated. No representative or employee of INOX/Unison Hardware, Inc. is authorized to make any modification or addition to this warranty.

UNISON HARDWARE, INC. MAKES NO OTHER WARRANTY, AND ALL IMPLIED WARRANTIES INCLUDING ANY WARRANTY OF MERCHANTABILITY OR FITNESS FOR A PARTICULAR PURPOSE ARE LIMITED TO THE DURATION OF THE EXPRESSED WARRANTY PERIOD AS SET FORTH ABOVE. THE COMPANY'S MAXIMUM LIABILITY HEREUNDER IS LIMITED TO THE PURCHASE PRICE OF THE PRODUCT. IN NO EVENT SHALL THE COMPANY BE LIABLE FOR ANY CONSEQUENTIAL, INDIRECT, INCIDENTAL OR SPECIAL DAMAGES OF ANY NATURE ARISING FROM THE SALE OR USE OF THIS PRODUCT, WHETHER IN CONTRACT, TORT, STRICT LIABILITY OR OTHERWISE. THIS LIMITED WARRANTY IS IN LIEU OF ALL OTHER WARRANTIES, EXPRESSED OR IMPLIED, INCLUDING THE IMPLIED WARRANTIES OF FITNESS AND MERCHANTABILITY. THERE ARE NO WARRANTIES WHICH EXTEND BEYOND THE DESCRIPTION ON THE FACE HEREOF.

Limited Electronics Warranty

Electronic Door Locks shall be free from defects in material and workmanship for one year.

INOX COMMERCIAL PRODUCT WARRANTY

Limited Commercial Warranty

Unison Hardware, Inc. ("INOX") warrants its commercial products shall be free from defects in material and workmanship under normal use and regular service and maintenance for a period of three (3) years from the date of delivery, excluding components made of wood, leather, or plastic.

If a product fails due to defects in material or workmanship during the warranty period, INOX will replace it with the most nearly identical product which we sell at the time. INOX will not be liable for any labor charges or freight costs incurred in connection with repair or replacement of a product. The sole and maximum liability for defective goods sold and manufactured by INOX shall never exceed the cost of the subject products.

This warranty does not cover:

1. Damage resulting from negligence, misuse, abuse, or accident occurring during or after installation
2. Damage due to use outside normal architectural requirements
3. Defects resulting from any modification or improper installation
4. Improper torquing (tightening) during or after installation
5. Improper door preparation
6. Use of residential grade products in commercial applications
7. Products installed in exterior application and/or exposed to the water, outdoor weather, or elements

Custom Items

Custom Items require special pricing and may not be covered under our warranty. Contact sales@unisonhardware.com for more information.

Limited Finish Warranty

Unison Hardware warrants its INOX products made of stainless steel material and with stainless steel finish (polished or satin) against tarnishing for up to three (3) years for commercial use so long as proper, regular care and maintenance occur.

This warranty does not cover:

- Damage resulting from using installation compounds that are harmful to metal finishes or using harsh cleaning solutions or any cleaning detergent containing chlorides, alcohol, or lime deposits
- Product installed in exterior applications and/or exposed to the water, outdoor weather or elements, or harsh environments
- Changes to living finishes that normally take place with the passage of time, including 10B Oil Rubbed Bronze and 19G Graphite Black
- Use in any manner contrary to INOX's printed instructions

CeraMax™ Finishes

CeraMax ceramic coating finishes are guaranteed against finish defects and cracking, chipping, peeling, and flaking under normal use for up to two (2) years. Ceramic coating will wear over time under normal use, and this warranty does not cover normal wear and tear of the product (which varies per color of finish) or any damage, alteration, or abuse to the finish from neglect or accident. Exterior installation, exposure to UV light or salt spray will affect ceramic coating as part of normal wear and tear. INOX CeraMax ceramic coating is not UV rated.

UNISON HARDWARE, INC. MAKES NO OTHER WARRANTY, AND ALL IMPLIED WARRANTIES INCLUDING ANY WARRANTY OF MERCHANTABILITY OR FITNESS FOR A PARTICULAR PURPOSE ARE LIMITED TO THE DURATION OF THE EXPRESSED WARRANTY PERIOD AS SET FORTH ABOVE. THE COMPANY'S MAXIMUM LIABILITY HEREUNDER IS LIMITED TO THE PURCHASE PRICE OF THE PRODUCT. IN NO EVENT SHALL THE COMPANY BE LIABLE FOR ANY CONSEQUENTIAL, INDIRECT, INCIDENTAL OR SPECIAL DAMAGES OF ANY NATURE ARISING FROM THE SALE OR USE OF THIS PRODUCT, WHETHER IN CONTRACT, TORT, STRICT LIABILITY OR OTHERWISE. THIS LIMITED WARRANTY IS IN LIEU OF ALL OTHER WARRANTIES, EXPRESSED OR IMPLIED, INCLUDING THE IMPLIED WARRANTIES OF FITNESS AND MERCHANTABILITY. THERE ARE NO WARRANTIES WHICH EXTEND BEYOND THE DESCRIPTION ON THE FACE HEREOF.

INOX ELECTRONIC PRODUCTS WARRANTY

Limited Electronic Warranty

Unison Hardware, Inc. ("INOX") warrants its electronic products shall be free from defects in material and workmanship under normal use and regular service and maintenance for one (1) year, excluding components made of wood, leather, or plastic.

If a product fails due to defects in material or workmanship during the warranty period, INOX will replace it with the most nearly identical product which we sell at the time. INOX will not be liable for any labor charges or freight costs incurred in connection with repair or replacement of a product. Our sole and maximum liability for defective goods sold and manufactured by INOX shall never exceed the cost of the subject products.

This warranty does not cover:

1. Damage resulting from negligence, misuse, abuse, or accident occurring during or after installation
2. Damage due to use outside normal architectural requirements
3. Defects resulting from any modification or improper installation
4. Improper torquing (tightening) during or after installation
5. Improper door preparation
6. Use of residential grade products in commercial applications
7. Products installed in exterior application and/or exposed to the water, outdoor weather, or elements

Custom Items

Custom Items require special pricing and may not be covered under our warranty. Contact sales@unisonhardware.com for more information.

Limited Finishes Warranty

Unison Hardware warrants its INOX Products made of stainless steel material and with stainless steel finish (polished or satin) against tarnishing for the life of the product for residential use and for up to three (3) years for commercial use so long as proper, regular care and maintenance occur. This warranty is extended to the original purchaser of INOX products if the user occupies the residential premises on which the products were originally installed.

This warranty does not cover:

- Damage resulting from using installation compounds that are harmful to metal finishes or using harsh cleaning solutions or any cleaning detergent containing chlorides, alcohol or lime deposits
- b. Product installed in exterior applications and/or exposed to the water, outdoor weather, or elements, harsh environments, and/or commercial or industrial applications
- c. Changes to living finishes that normally take place with the passage of time, including 10B Oil Rubbed Bronze and 19G Graphite Black
- d. Use in any manner contrary to INOX's printed instructions

CeraMax™ Finishes

CeraMax ceramic coating finishes are guaranteed against finish defects and cracking, chipping, peeling, and flaking under normal use for up to two years for commercial use. Ceramic coating will wear over time under normal use, and this warranty does not cover normal wear and tear of the product (which varies per color of finish) or any damage, alteration, or abuse to the finish from neglect or accident. Exterior installation, exposure to UV light or salt spray will affect ceramic coating as part of normal wear and tear. INOX CeraMax ceramic coating is not UV rated. No representative or employee of INOX/Unison Hardware, Inc. is authorized to make any modification or addition to this warranty.

UNISON HARDWARE, INC. MAKES NO OTHER WARRANTY, AND ALL IMPLIED WARRANTIES INCLUDING ANY WARRANTY OF MERCHANTABILITY OR FITNESS FOR A PARTICULAR PURPOSE ARE LIMITED TO THE DURATION OF THE EXPRESSED WARRANTY PERIOD AS SET FORTH ABOVE. THE COMPANY'S MAXIMUM LIABILITY HEREUNDER IS LIMITED TO THE PURCHASE PRICE OF THE PRODUCT. IN NO EVENT SHALL THE COMPANY BE LIABLE FOR ANY CONSEQUENTIAL, INDIRECT, INCIDENTAL OR SPECIAL DAMAGES OF ANY NATURE ARISING FROM THE SALE OR USE OF THIS PRODUCT, WHETHER IN CONTRACT, TORT, STRICT LIABILITY OR OTHERWISE. THIS LIMITED WARRANTY IS IN LIEU OF ALL OTHER WARRANTIES, EXPRESSED OR IMPLIED, INCLUDING THE IMPLIED WARRANTIES OF FITNESS AND MERCHANTABILITY. THERE ARE NO WARRANTIES WHICH EXTEND BEYOND THE DESCRIPTION ON THE FACE HEREOF.

Care & Maintenance

Lever and Knob Handles

When installed correctly in accordance with the instructions, levers will not require initial adjustment. All fixings should be checked **from time to time based on conditions of use to adjust or tighten if needed**. Badly fitted hardware can cause interference with the operation of the lock and damage the surface or finish.

INOX® snap-on rose covers should only be removed using proper tools. **Be extremely careful to avoid marring the door and hardware finish if removing a snap-on rose cover. Contact INOX for more information.**

Care of Finishes

Today's environment exerts an immense toll on product material; hardware must be able to stand up to such atmospheric conditions as pollution, salt spray, and high humidity. Additionally, products must be protected against cleaning agents/solutions, and ideally the product should offer hypo-allergenic properties. Here are some tips **for** taking care of INOX finishes.

Stainless Steel is renowned for superior resistance to corrosion and for high performance with low maintenance. Stainless steel corrosion resistance is due to the presence of a thin, durable film of passive but stable chromium oxide. This film is inert, invisible, extremely adherent, and self-repairing, so it provides an unrivaled protection for steel; should the film be damaged or removed it will regenerate independently, provided oxygen is present to allow the reaction to occur with the chromium content of the steel. Therefore, you should ensure regular cleaning and maintenance of the hardware to restore the original surface appearance, prevent corrosion, and maintain hygienic conditions.

Cleaning

- Initially, wash down the surface using **a special polishing agent for stainless steel, such as Flitz, or soapy water or a very mild detergent**.
- Always thoroughly rinse the cleaning agent away with clean, warm water.
- Dry and polish the item with a soft, dry cloth. With aggressive conditions such as offshore, marine, and swimming pool environments, it is especially important to ensure that cleaning maintenance occurs regularly. Discoloration - If spots appear on the surface it is **not a property of** the stainless steel, but impurities in the water, the air or to cleaning agents that have not been thoroughly removed from the surface.
- Spots can be avoided by careful cleaning.
- If discoloration or spots occur, remove by using special polishing agents for stainless steel or a light scouring cream.
- Finally, rinse thoroughly with clean water and polish with a soft, dry cloth.

What to Avoid!

- Scouring powders **and pads**
- Steel wool
- Strong abrasive materials

Care of CeraMax™ Finishes

- CeraMax ceramic coating finishes can be easily cleaned by wiping with acetone or Windex® and a microfiber cloth. Never use abrasives **to clean ceramic coating**.

For further information on stainless steel **or CeraMax**, please contact your local INOX® sales representative.

INOX

6 Wayne Court, Sacramento, CA 95829, USA
 Tel: +1.916.388.1888 Fax: +1.916.388.8322
 Email: info@unisonhardware.com Web: www.inoxproducts.com

Terms and Conditions

PRICING

- List prices are effective on the date appearing on the cover and are subject to change without notice. List Prices are subject to discounts in effect at the time orders are acknowledged in writing.
- If, under any law now or hereafter passed, the seller is required to pay a tax on sales or an excise tax, the amount of these taxes will be added to the invoice value.
- Errors or omissions are subject to correction.
- All quoted jobs must clearly reference the quote number on the purchase order to receive special quoted prices.
- Delivery – Unison Hardware, Inc. (“INOX”) will not be responsible for any loss or damage resulting from delay in filling orders caused by fire, flood, strikes, differences with workers, government regulations, accidents, transportation delays, shortages of materials, or other causes beyond our control.
- Materials – Should raw material prices rise substantially it may become necessary to add a surcharge by material type at the time of shipment. Orders are processed in order of receipt but lead times will vary in relation to production specifications. Errors or omissions in published prices are subject to correction.

PAYMENT

- Unison Hardware, Inc. (“INOX”) will provide an invoice by email to customer once products have been shipped. Printed copies are only available upon request.
- Customer shall make payment in US Dollars to INOX according to the invoice amount without any other deduction, credit or set off within 30 (Thirty) Days of the date of invoice; or otherwise in accordance with such credit terms as may have been agreed in writing between INOX and the Customer.
- If a payment by check incurs a NSF (non-sufficient funds) bank charge a \$50.00 fee will be added to the account.
- INOX is not obliged to accept orders from any Customer who has not supplied INOX with references satisfactory to INOX. If at any time INOX is not satisfied as to the creditworthiness of the Customer, it may give notice in writing or electronically to the Customer that no further credit will be allowed to the Customer, in which event no further goods or services will be delivered or provided to the Customer other than against advance cash payment; and all amounts owing by the Customer to INOX shall be immediately payable.
- Customer accounts unpaid at the expiration of 90-days from the date of invoice will be subject to a late payment charge of 2% per month of the total balance or the highest rate permissible by law if less. Also, accounts unpaid after 90-days will be subject to C.O.D. shipments. Accounts unpaid after 90-days will be placed for collection. All collection charges, attorney fees, and court costs will be added to the amount due.
- Discount level, credit limit and payment terms will be re-evaluated for accounts unpaid 3 times at expiration of 90-days from the date of invoice.
- Prepayment Terms:
 - * Payment must be received in full before shipments are released.
 - * All Customer accounts are on prepayment term until credit application is submitted and approved. A credit application form must be filled out and is subject to approval before any credit payment terms are extended to Customers.
 - * For special order items, a deposit may be required before production starts.
 - * For orders over Customer’s credit limit, prepayment of the difference must be collected before order is accepted.

MINIMUM ORDER CHARGES

- Orders with a net value of less than \$50.00 are subject to a \$5.00 handling fee added to the invoice.

MINIMUM ANNUAL PURCHASE REQUIREMENTS FOR ACTIVE ACCOUNT

- A minimum annual purchase amount of \$7500.00 is required to maintain an open account with INOX.

PRODUCT CHANGES

- INOX reserves the right to make changes or improvements in design, material, parts, or specifications, as well as to discontinue products at any time.

Terms and Conditions

SHIPPING AND FREIGHT CHARGES

- All shipments are F.O.B. Sacramento CA. Shipping is prepaid to the contiguous U.S. on orders having a value of \$1,000.00 net with standard discount. Freight prepaid on orders of \$2,500 net or more to Alaska, Hawaii and Canada. Shipping and Freight prepaid on shipments of \$2,500 net or more for projects with deeper than standard discounts. Any other international destination shipping and/or freight to be quoted. Any request for shipments not falling under these guidelines may be subject to a handling charge.
- INOX will not provide consignee or third-party freight billing.
- Requests for shipping methods other than Ground, e.g., Next Day, 2 Day, 3 Day, etc., must be made in writing.

ORDER CANCELLATIONS

- Any orders for made-to-order and/or non-stock goods accepted by INOX are non-cancellable except with prior written consent, and if consent is granted will be subject to a service charge based on the manufacturing expenses incurred. Under no circumstances will non-stock, made-to-order or discontinued product be accepted for return unless due to INOX error.

RETURN GOODS AUTHORIZATION POLICY

- INOX accepts returns of resalable items with original packaging within 90 days of invoice date, subject to a 30% restocking fee and customer-paid return shipping. Returns require a Return Goods Authorization (RGA) and minimum value of \$25. Custom hardware, specialty finishes (CeraMax ceramic coating, laser art), and OEM products are non-returnable. For warranty claims on defective items, INOX conducts inspection upon receipt. Approved warranty claims receive reimbursement or replacement of the item, including shipping charges. Customers have 5 business days to provide disposal instructions for rejected returns, after which items will be recycled. Visit <https://www.inoxproducts.com/faqs> for complete details and return initiation.

WARRANTY RETURNS

- A credit in the amount of the original purchase order will be issued after the returned product is inspected and the defect is found to be valid.

DELIVERY AND INSPECTION

- Customer will inspect all product deliveries immediately upon receipt. INOX will assume acceptance of delivered product if not notified within 5-days of receipt of product.

CLAIMS

- All claims should be submitted to INOX as follows:
- All claims for pricing adjustments must be submitted within 30-days of invoice date.
- All claims for order quantity discrepancies must be submitted within 5-days of receipt of product.
- All claims for damaged material prior to acceptance by customer must be submitted within 5-days of receipt of product.

LIMITED WARRANTY

- Subject to the limitations of liability set forth below, Unison Hardware, Inc. ("INOX") warrants to first purchaser that the products which INOX sells under the "Unison" and/or "INOX" trademark/s and/or trade names are free from defects in workmanship and materials under normal use and regular service and maintenance from date of delivery.
- This is the sole and exclusive warranty given by INOX with respect to the products and is in lieu of any and all other warranties, express or implied, arising by operation of law or otherwise. All implied warranties, including but not limited to the warranties of merchantability, non-infringement and fitness for a particular purpose, are hereby excluded.
- This warranty does not cover defects or damage arising from improper installation, incorrect application, lack of or improper maintenance, improper storage, shipping and handling, excessive wear and tear, misuse, abuse, accident, unauthorized service, or use with unauthorized products or parts. INOX warrants its products from the date of delivery for a period as follows:

Terms and Conditions

	Residential		Commercial	
	Interior	Exterior*	Interior	Exterior*
Mechanical	10-Year	3-Year	3-Year	1-Year
Electronic	2-Year	1-Year**	1-Year	1-Year**
Finish	Stainless Steel	10-Year	3-Year	1-Year
	PVD	10-Year	3-Year	1-Year
	CeraMax	10-Year	3-Year	1-Year
	Powder Coating	10-Year	3-Year	1-Year
	ElectroPlated	2-Year	1-Year	1-Year
	Living Finish Unlacquered	N/A	N/A	N/A

*Exterior means doors facing outside of the property but with overhang.

Completely exposed under the weather is not included in this warranty unless it has an IP65 Outdoor Rating.

** Only when products with IP65 outdoor rating.

The sole and exclusive liability of INOX under this warranty or otherwise, shall be limited to the repair or replacement of any product or component part which shall prove defective to the original purchaser from INOX. INOX will not pay for the costs or repair performed other than in accordance with this warranty. INOX shall not be liable for damages caused by delay in performance and in no event, regardless of the form of the claim or cause of action (whether based on contract, infringement, negligence, strict liability, other tort or otherwise) shall INOX's liability to purchaser and/or its customers exceed the price paid by purchaser for the specific products giving rise to the claim or cause of action. Purchaser agrees that in no event shall INOX's liability to purchaser and/or its customers extend to include incidental, consequential or punitive damages resulting from use of these products or arising out of any breach of this warranty. The term "consequential damages" shall include, but is not limited to, loss of anticipated profits, business interruption, loss of use or revenue, cost of capital or loss or damage to property or equipment. The foregoing limitations and exclusions are intended to be effective to the maximum extent permitted by law. This warranty is governed by the law of the State of California without regard to its conflicts of law principles. INOX and purchaser agree that the United Nations Convention on Contracts for the International Sale of Goods and the United Nations Convention on the Limitation Period in the International Sale of Goods shall not apply to sales of the products covered by this warranty.

Written notice of a product believed to be defective as covered by this Warranty should be sent to Unison Hardware, Inc. (INOX), 6 Wayne Court, Sacramento CA 95829 within 30-days from the discovery of the alleged defects, and should include the purchaser's name and address, identification of the product, and brief description of the defect. Upon receipt of such notice, INOX will inform the purchaser where to ship such product, shipping charges prepaid, for examination. In the event such examination reveals a defect covered by this warranty, INOX will, at its own option, repair or replace the product, and return it or the replacement to the purchaser, with charge only for transportation.

The completion, signing and submission of this Agreement by Customer to INOX for consideration of a credit account constitute understanding and acceptance of this Agreement's terms and conditions.

Please visit our website
www.inoxproducts.com
www.inoxsmart.com
for more technical and new product information.

INOX™

6 Wayne Court, Sacramento, CA 95829, USA

Tel: +1.916.388.1888

Email: info@unisonhardware.com

Web: www.inoxproducts.com

DEPARTMENT EMAIL

Purchase Orders: orders@unisonhardware.com

Account Management: sales@unisonhardware.com

Return Requests: returns@unisonhardware.com

Marketing: marketing@unisonhardware.com

Support: support@unisonhardware.com

Sales: sales@unisonhardware.com